

SOL15-6367-503

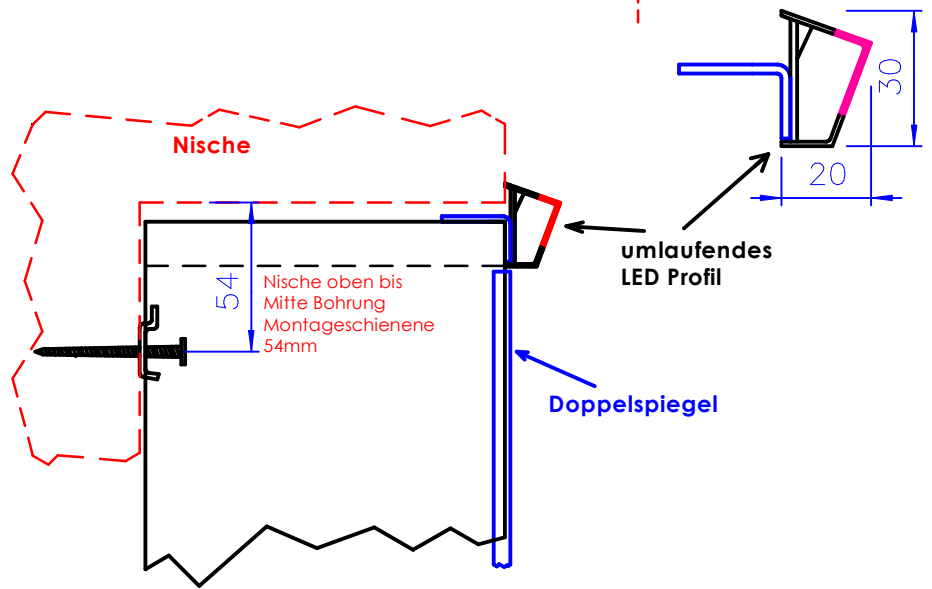

SOL15-6867-503

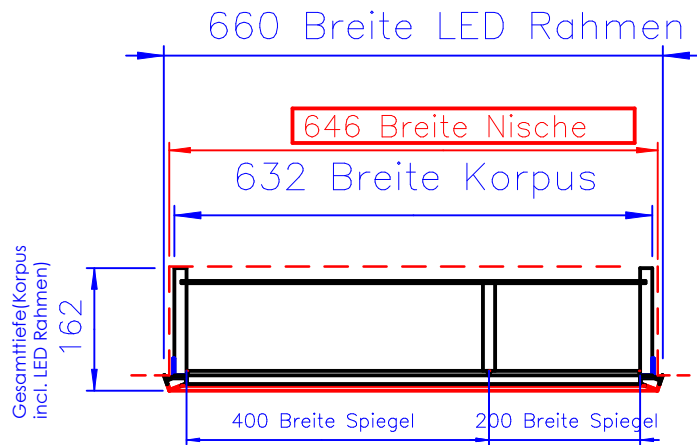
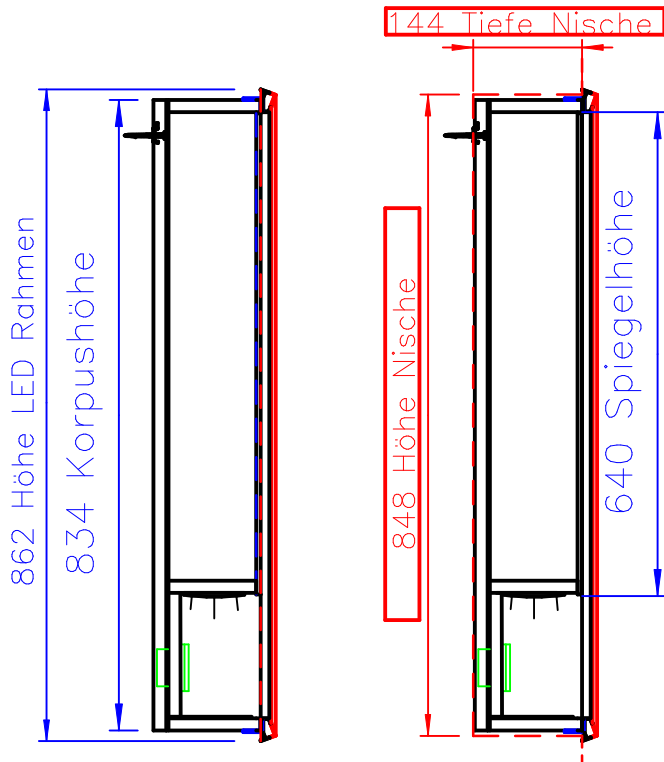
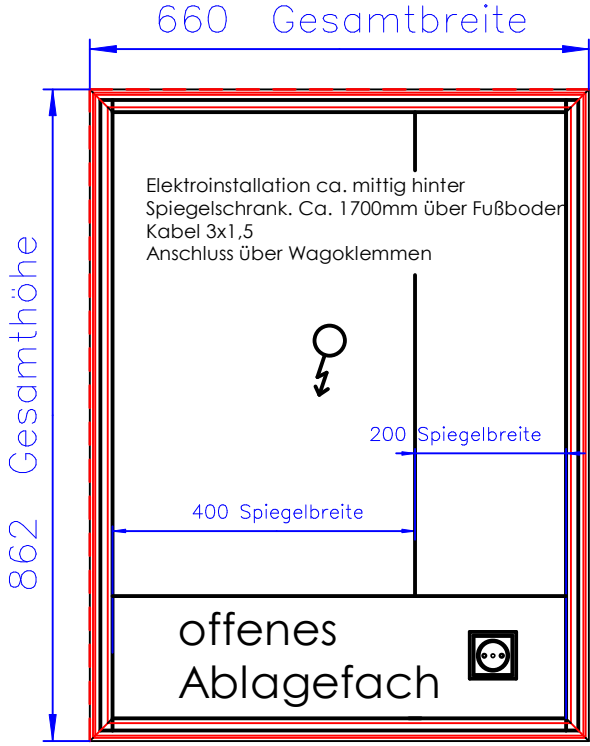
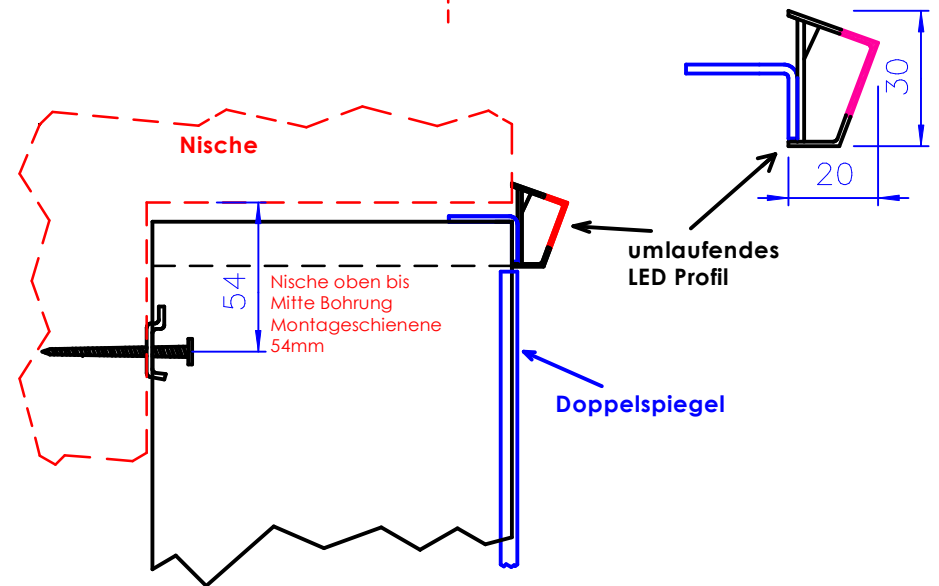
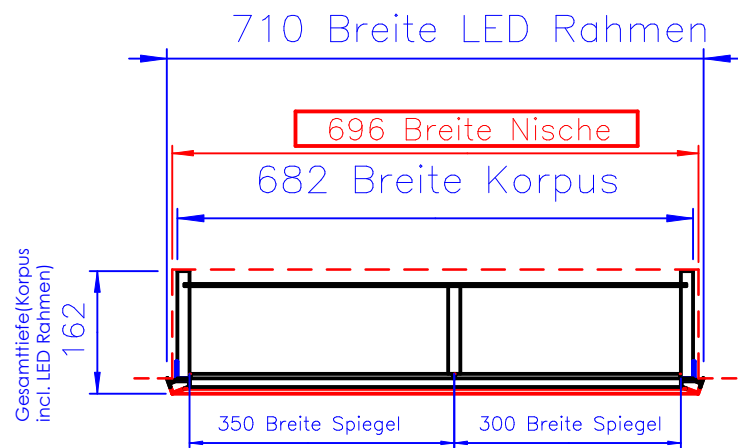
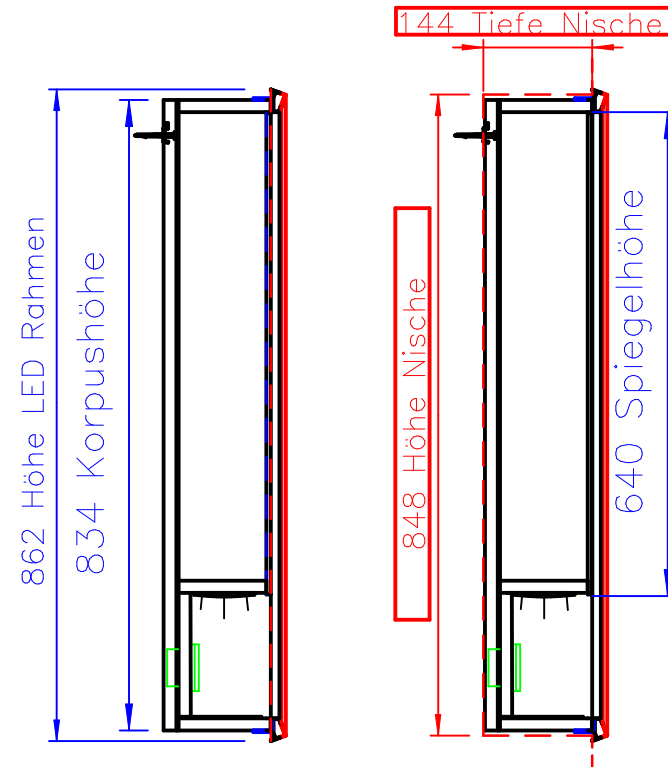
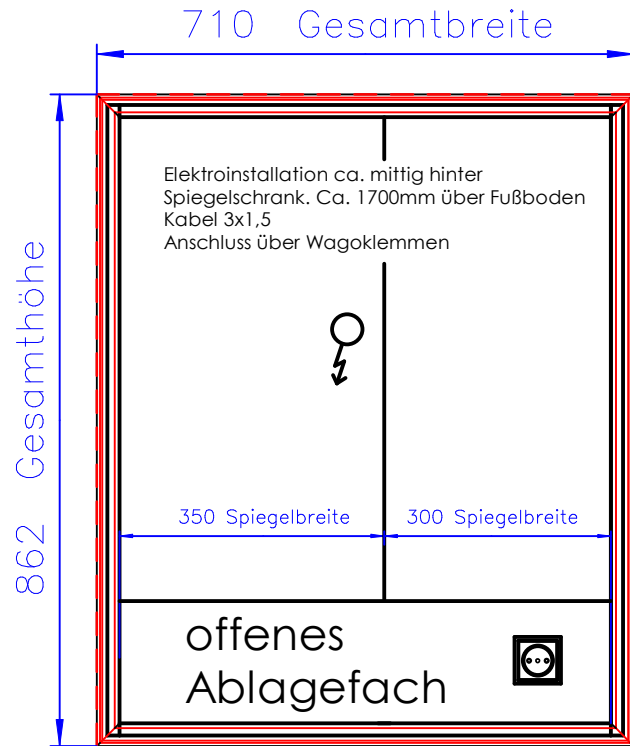

SOL15-7367-503

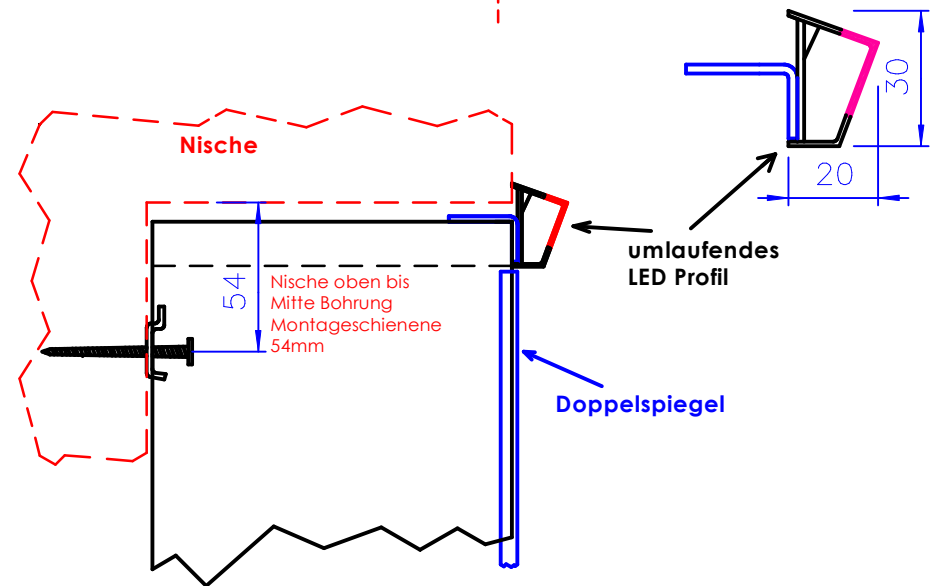
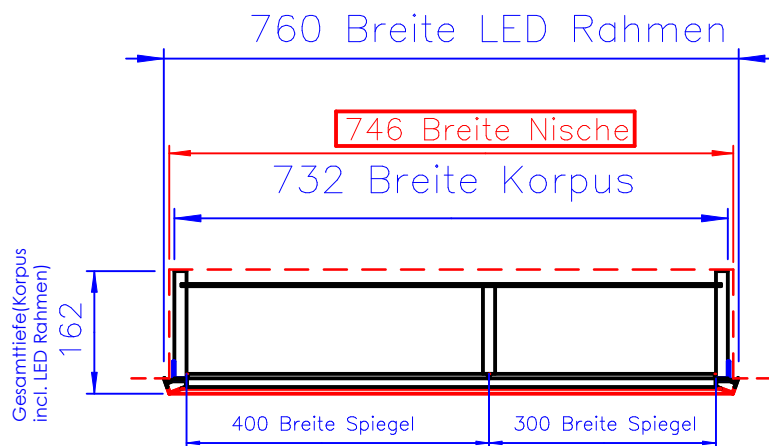
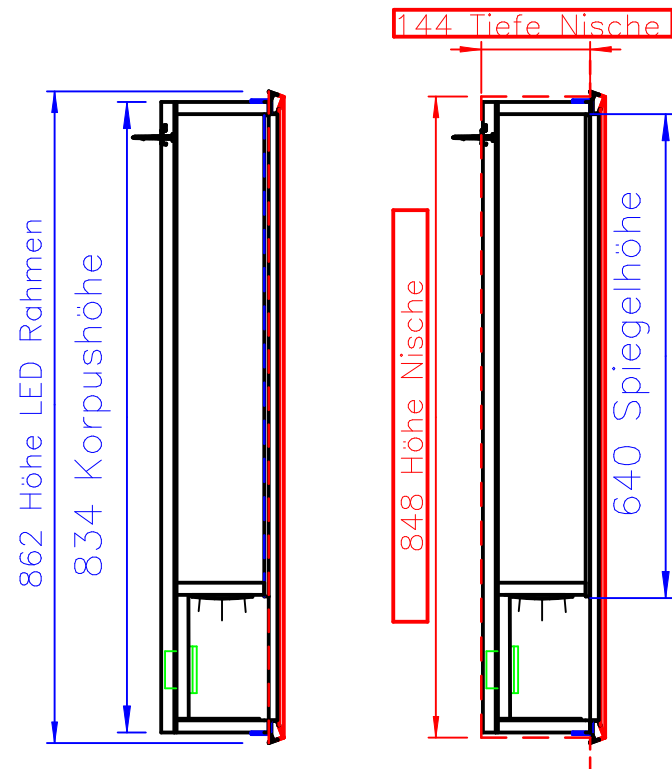
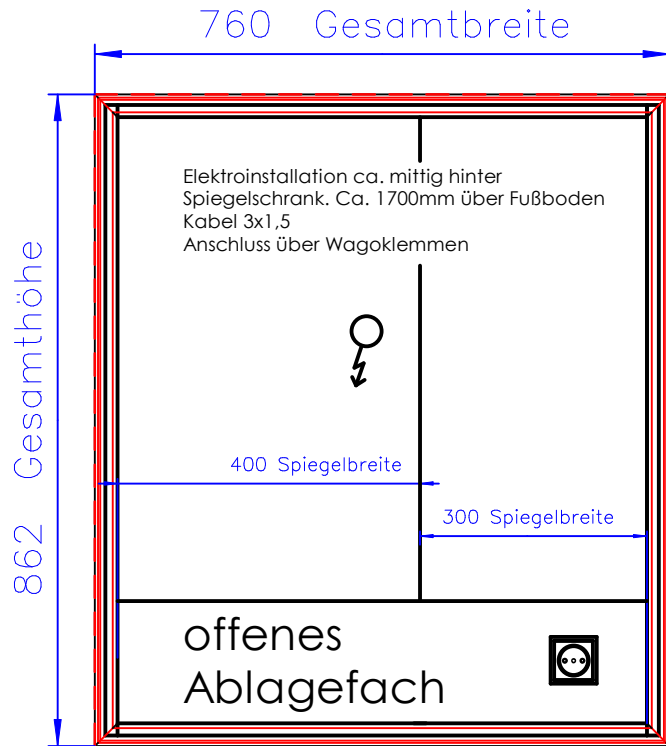

SOL15-7867-503

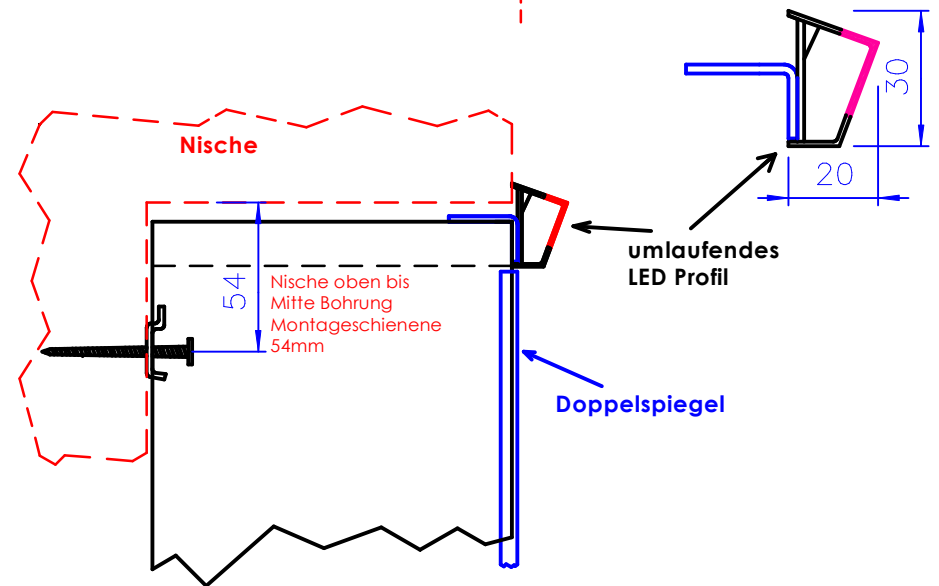
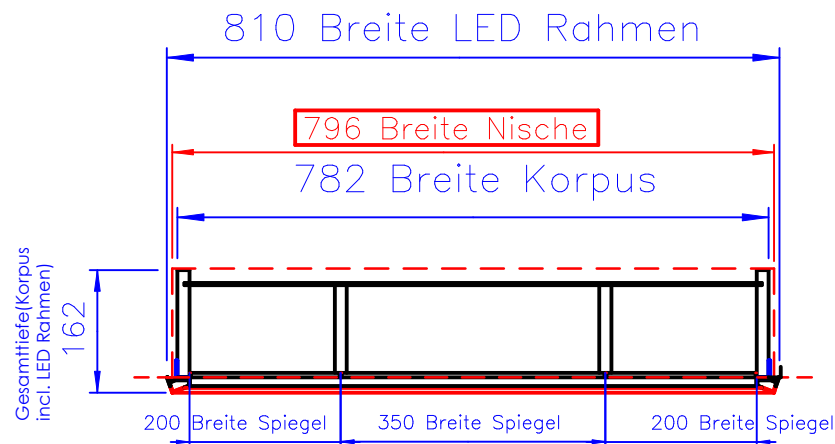
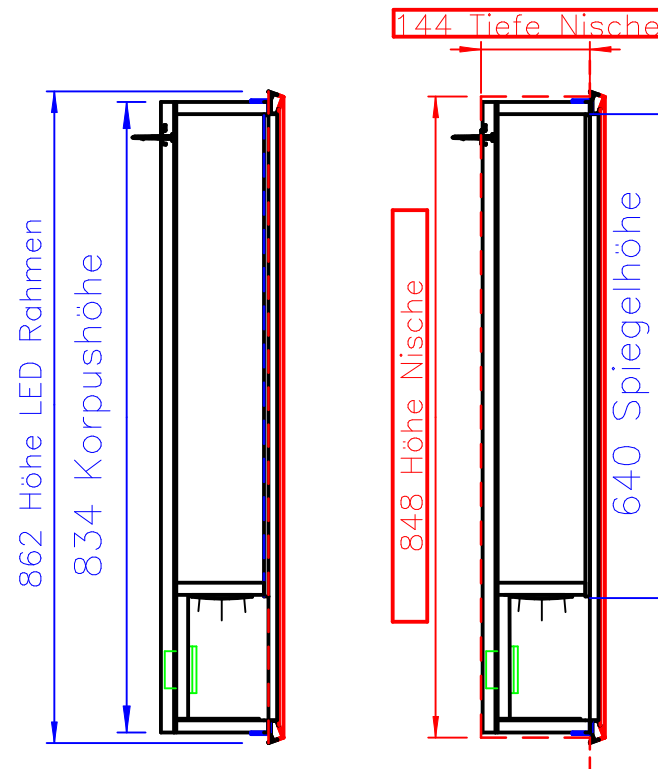
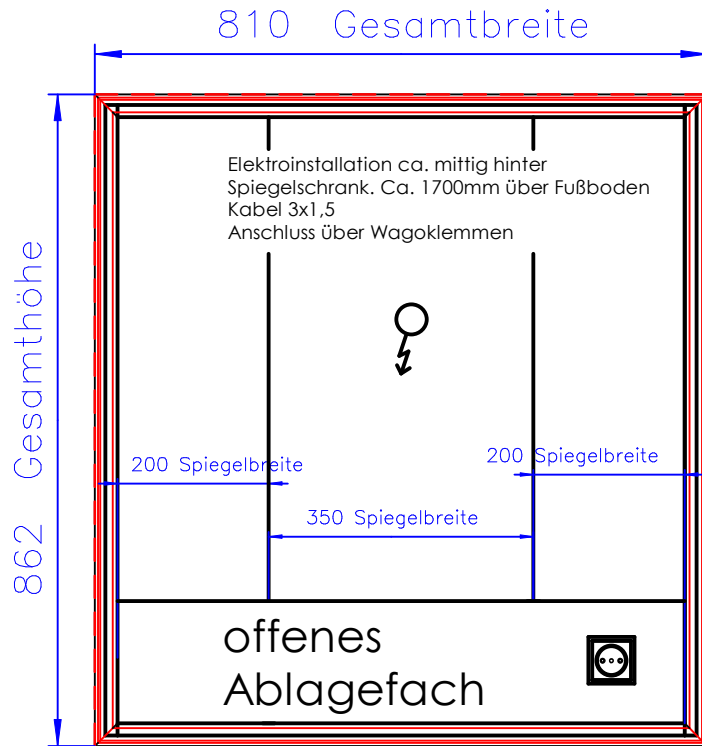

SOL15-8367-503

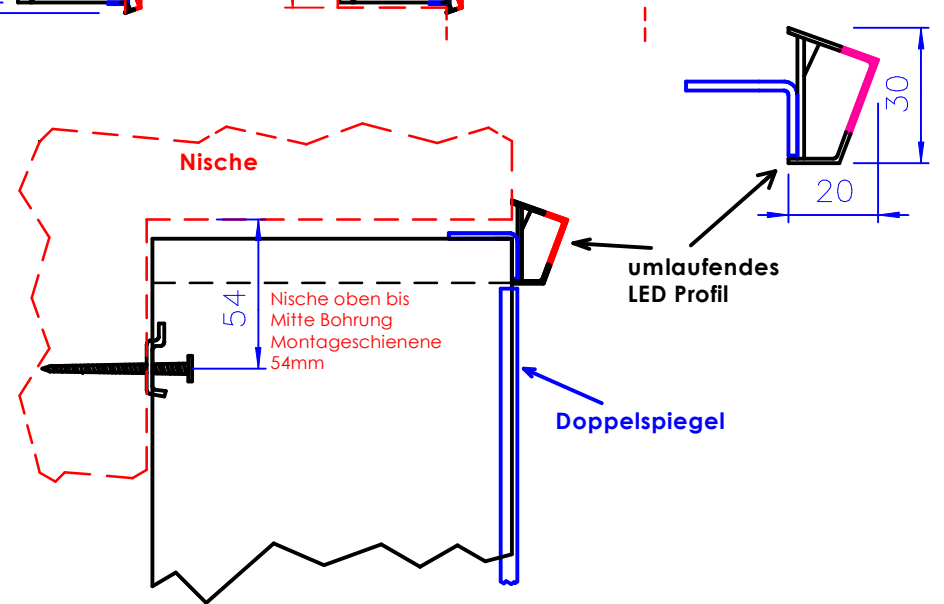
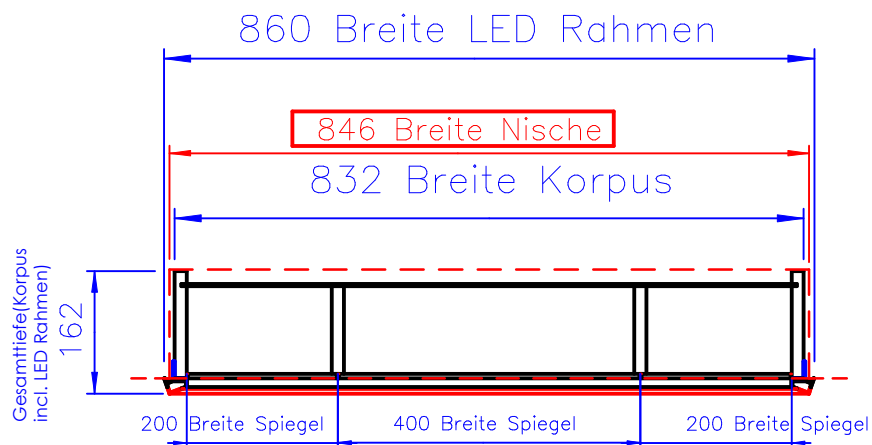
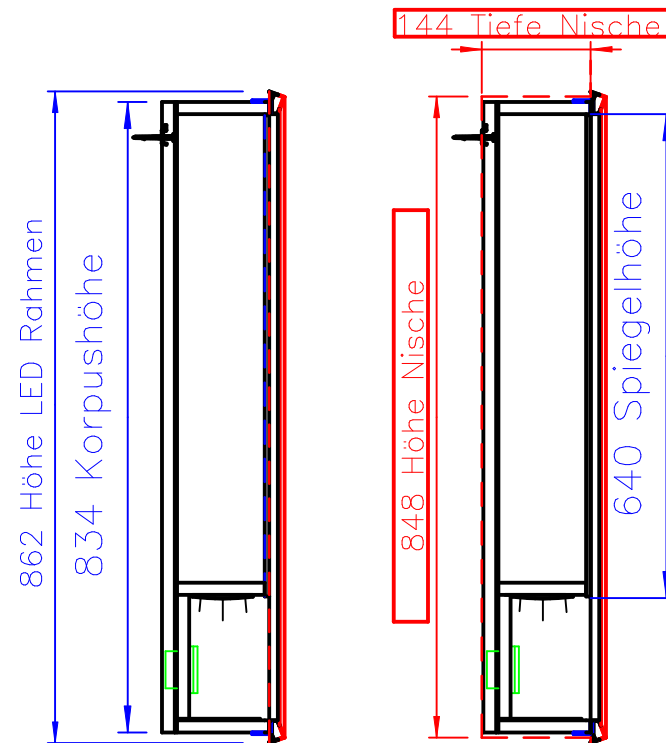
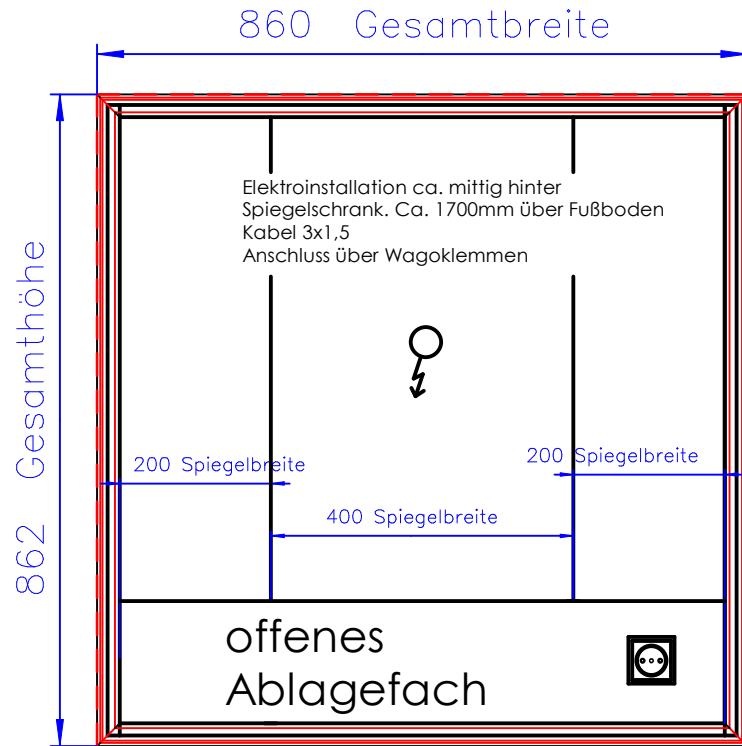

SOL15-8867-503

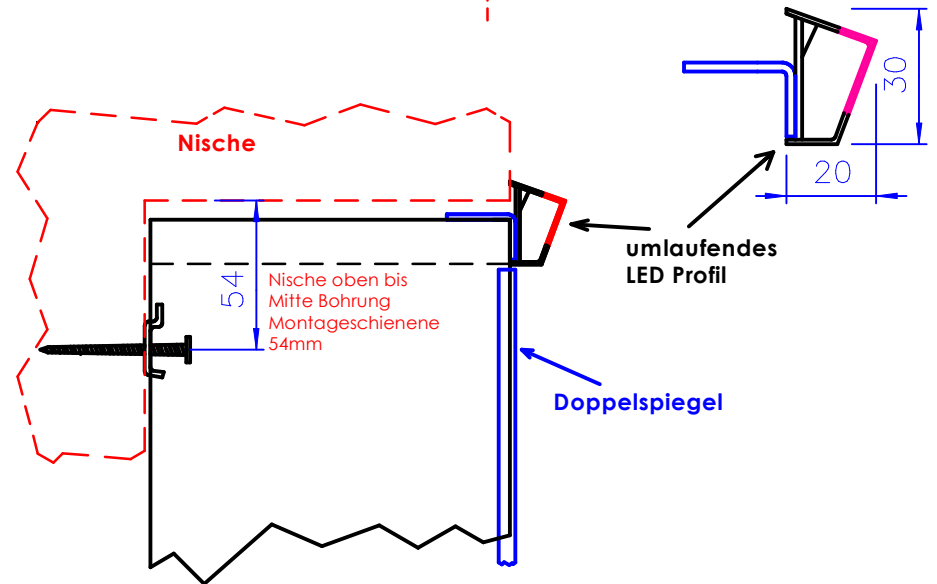
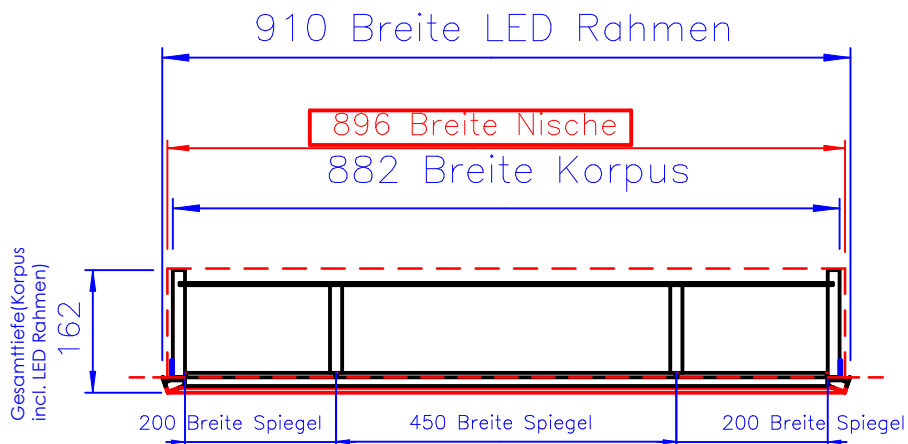
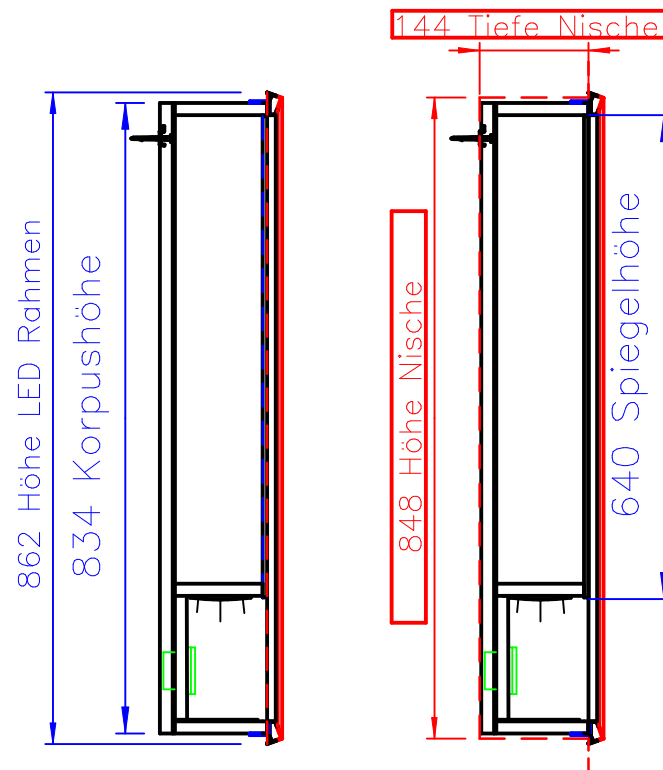
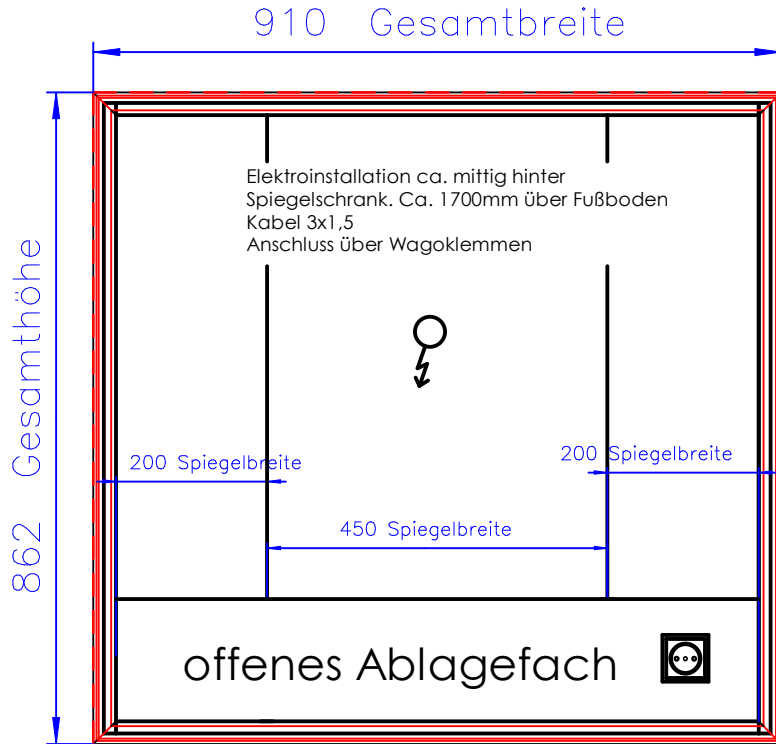

SOL15-9867-503

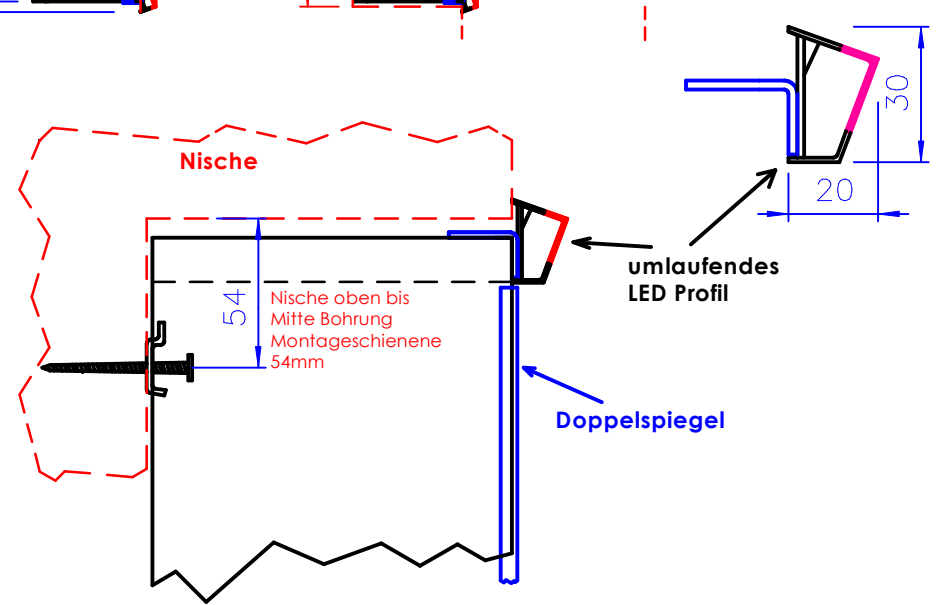
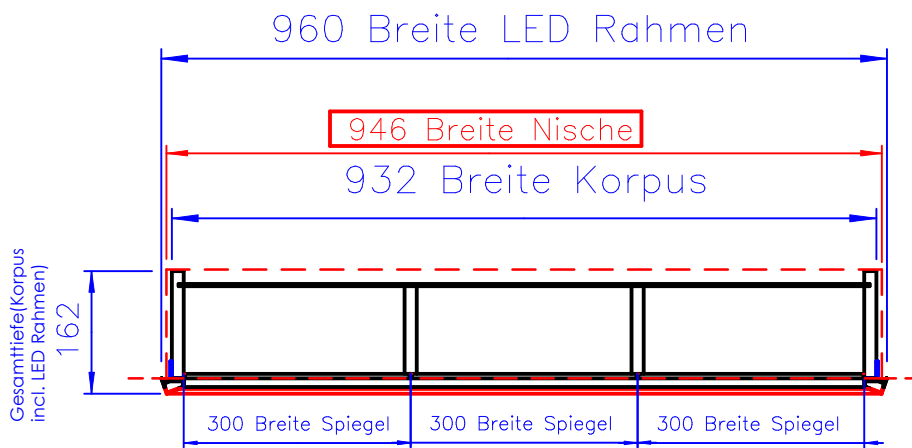
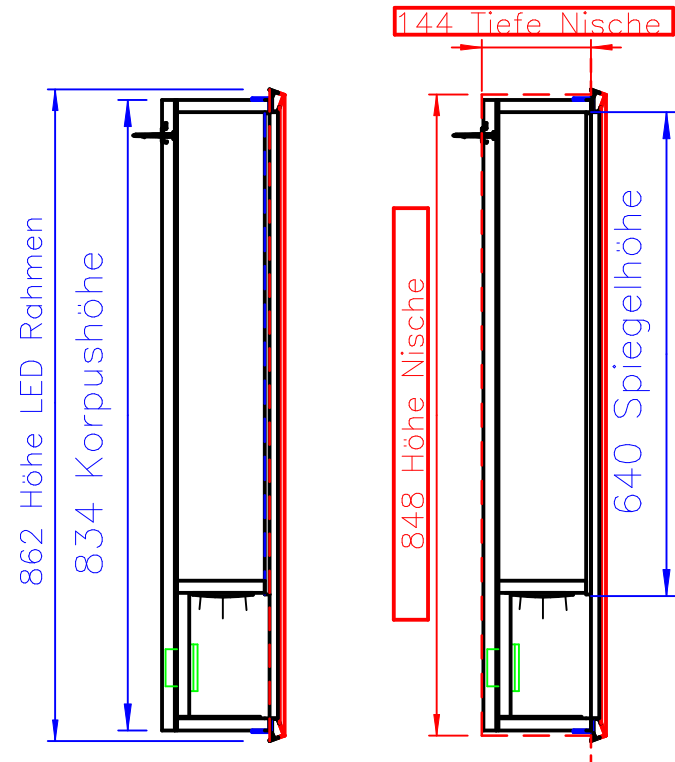
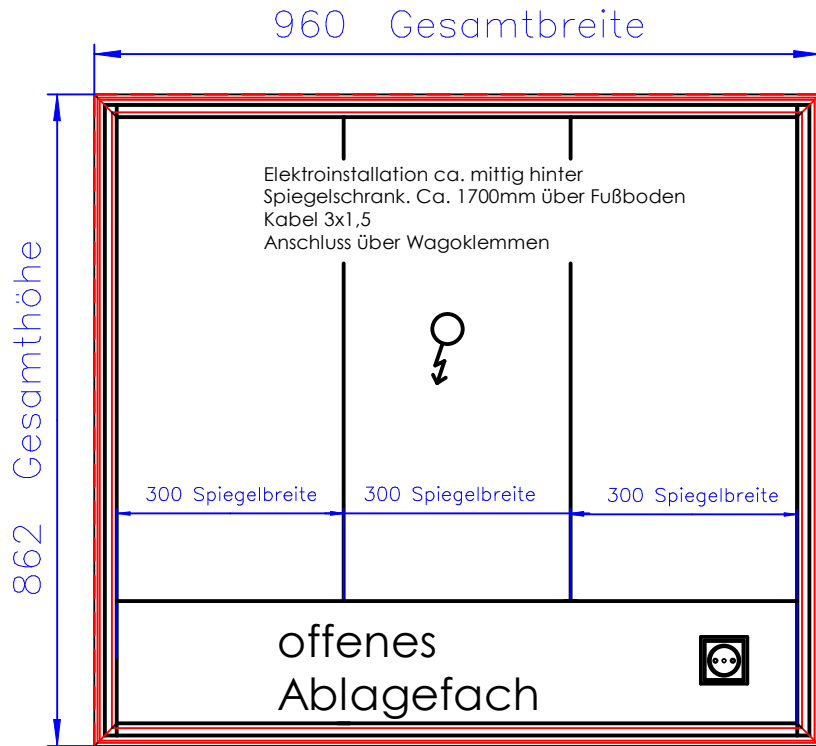

SOL15-9867-503

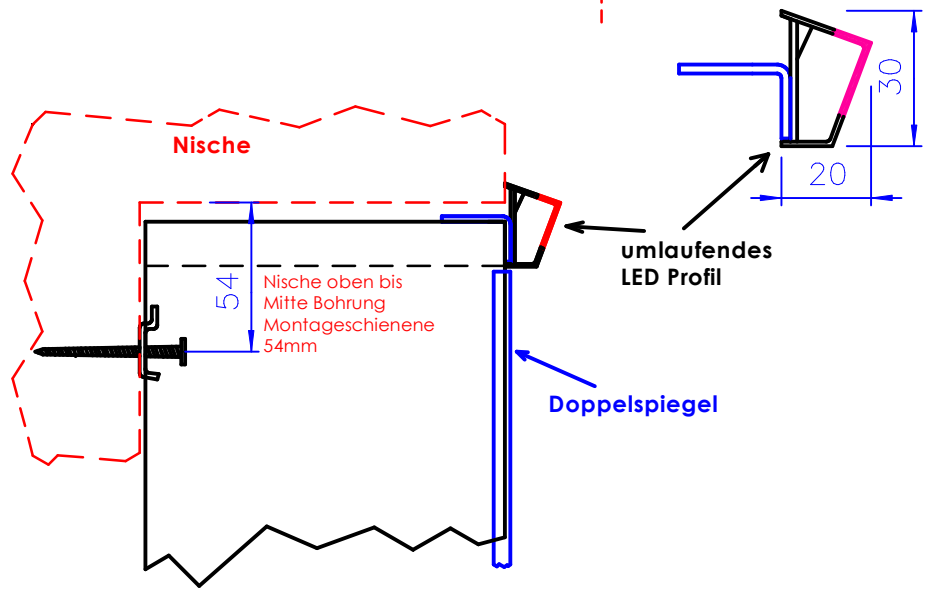
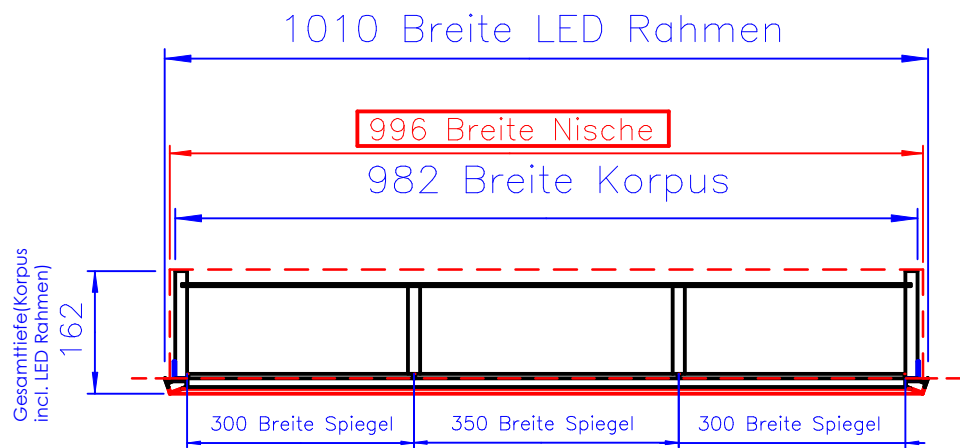
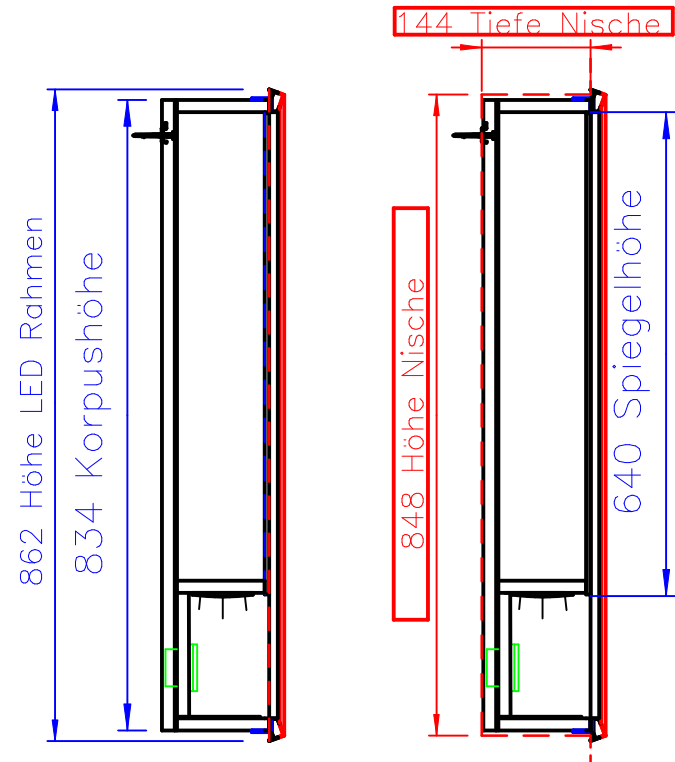
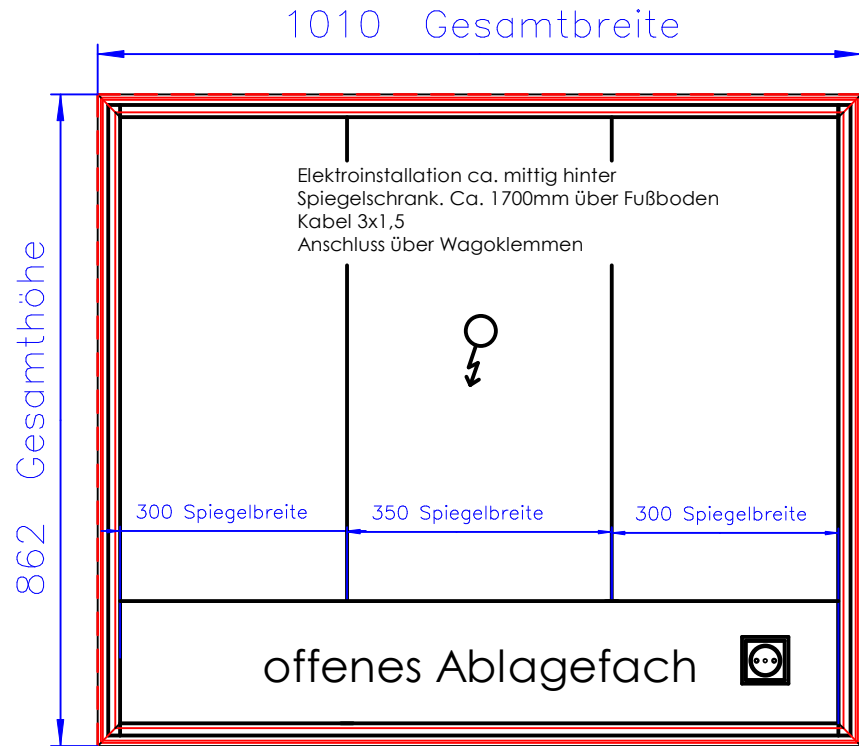

SOL15-10367-503

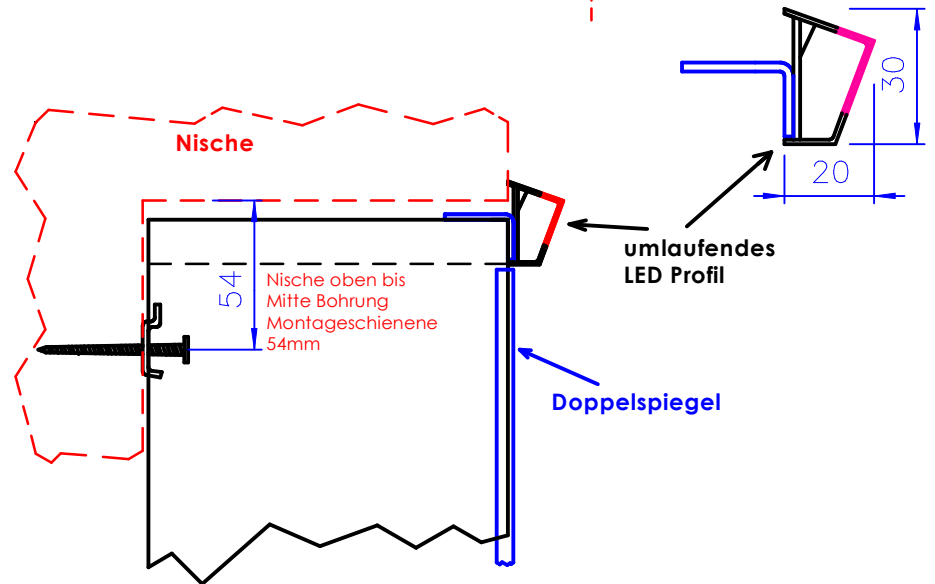
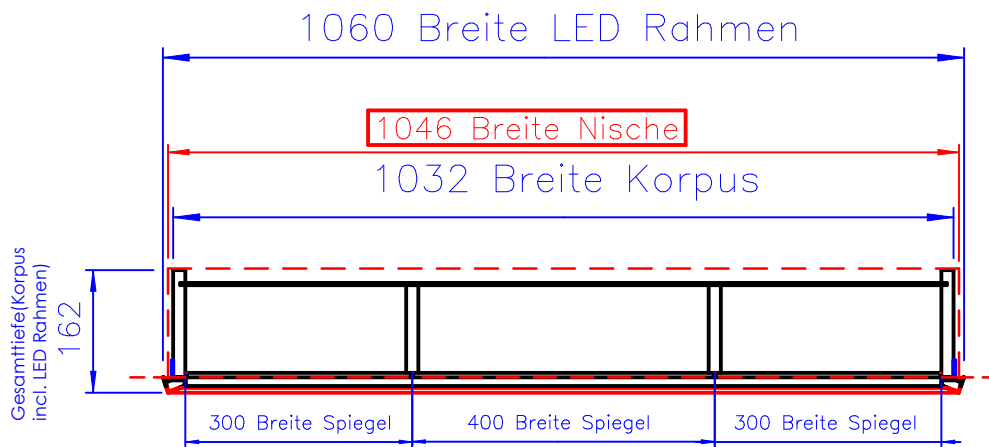
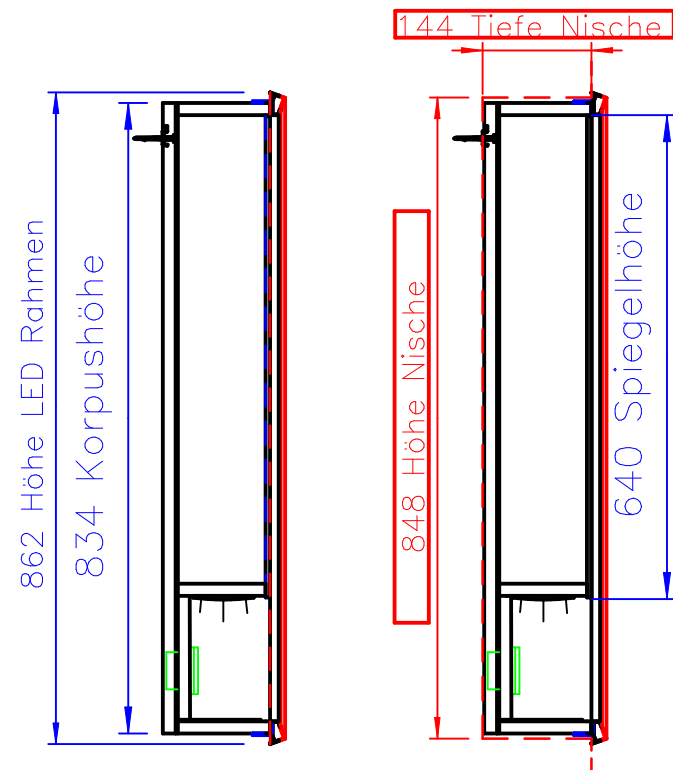
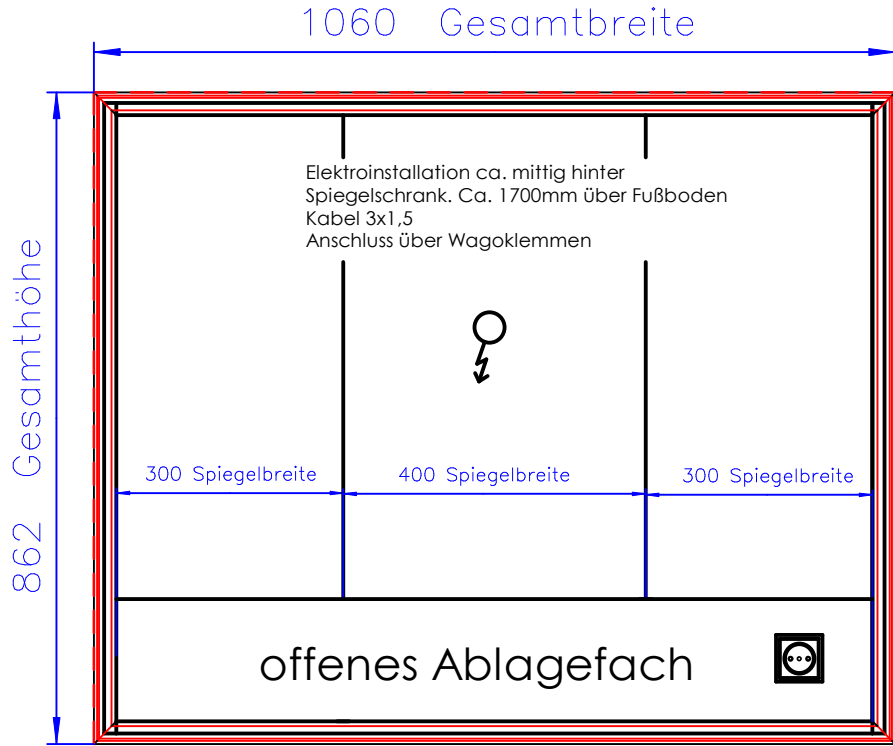

SOL15-10867-503

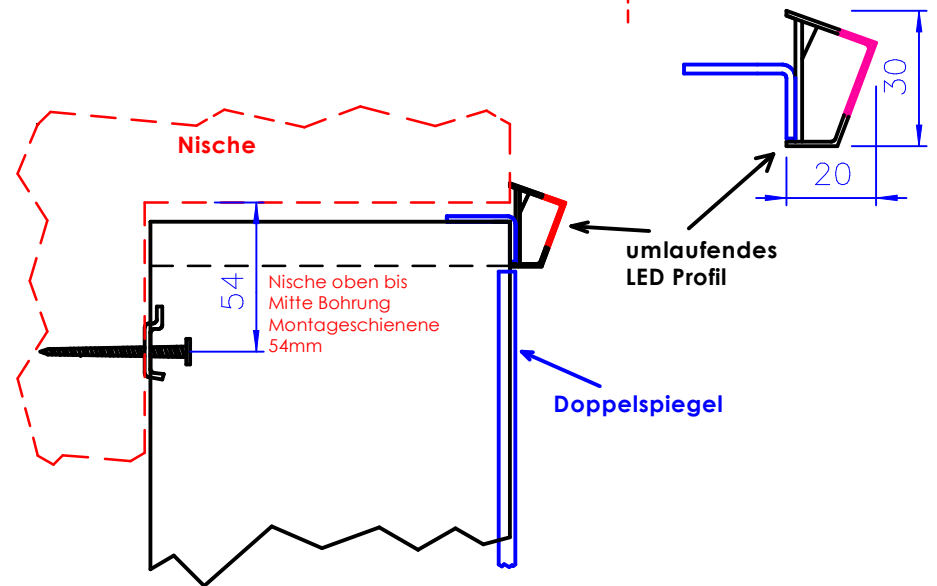
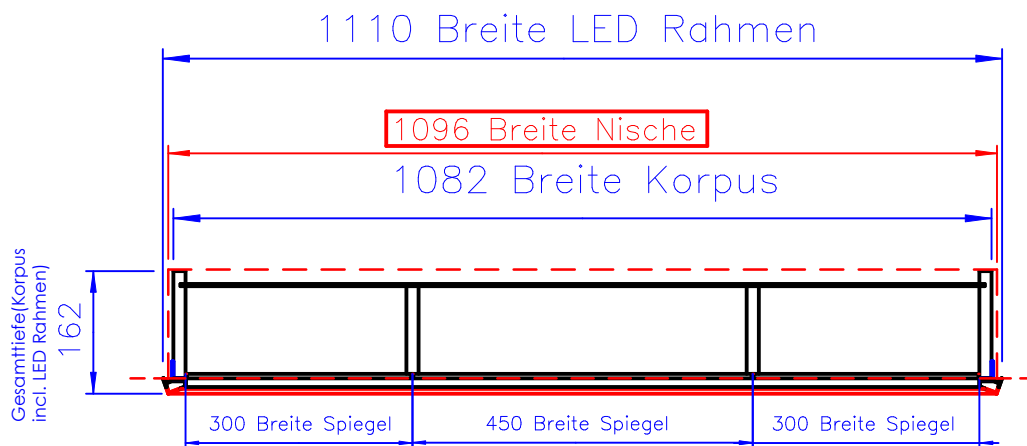
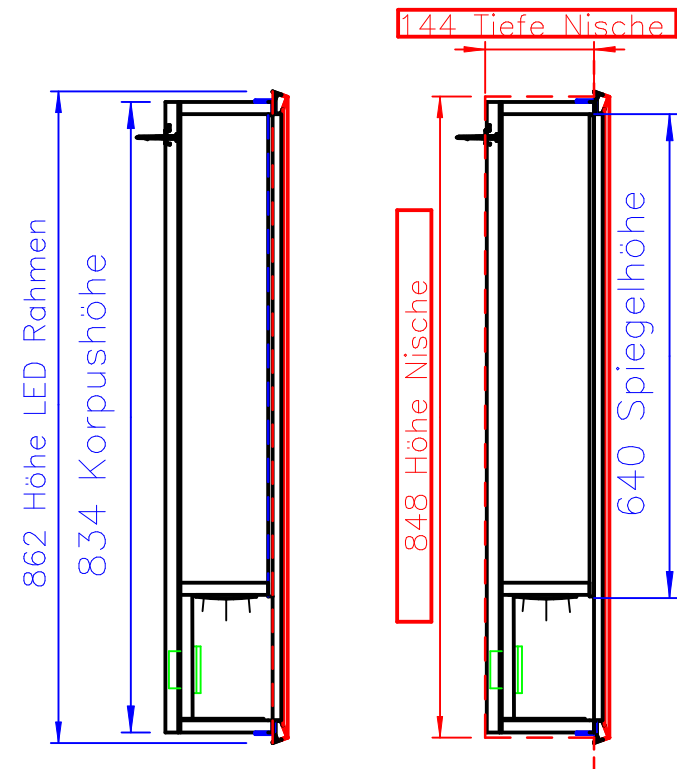
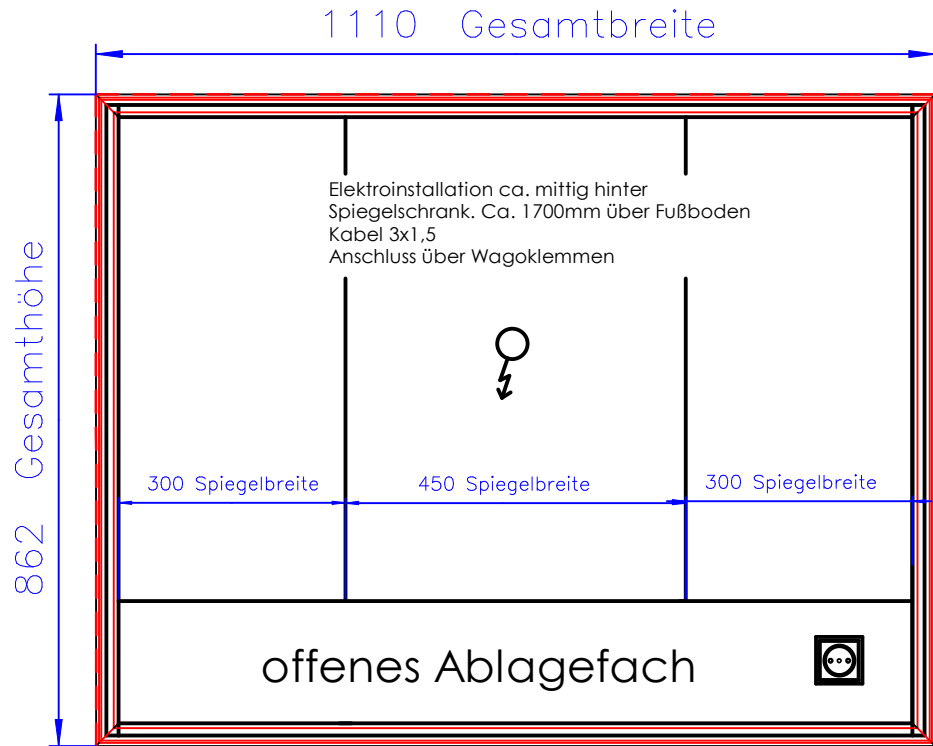

SOL15-11367-503

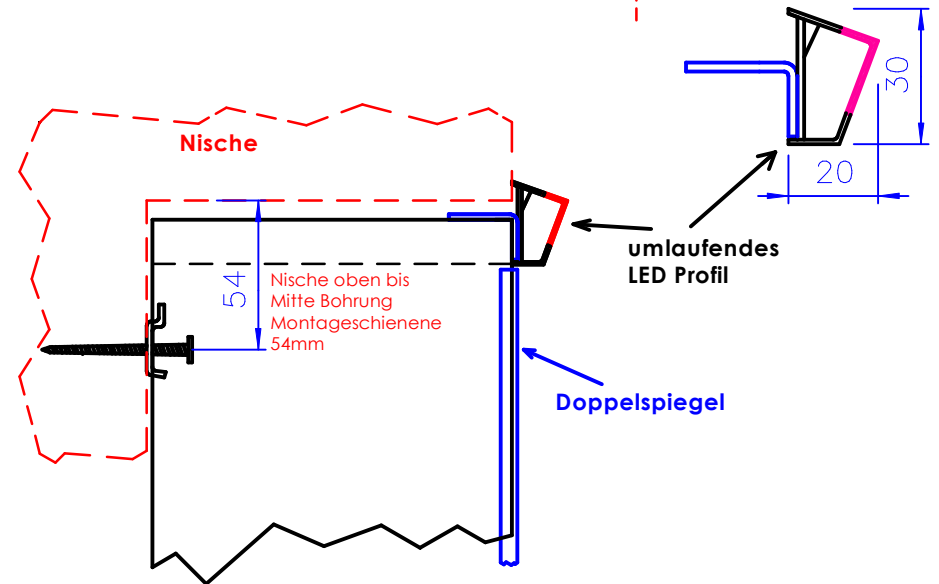
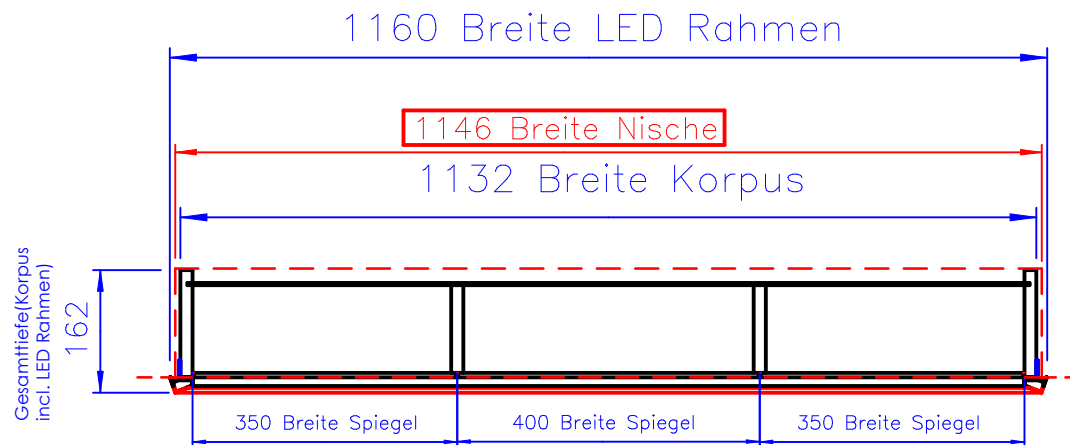
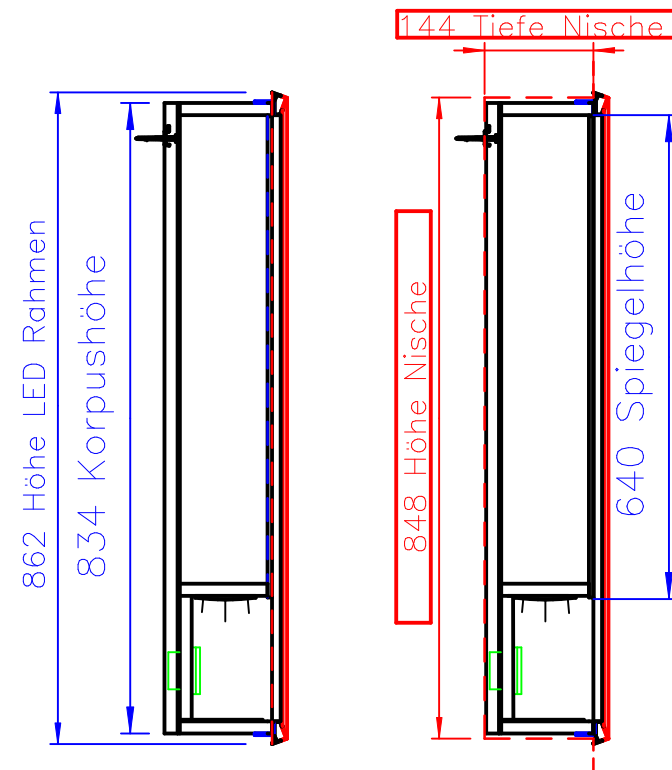
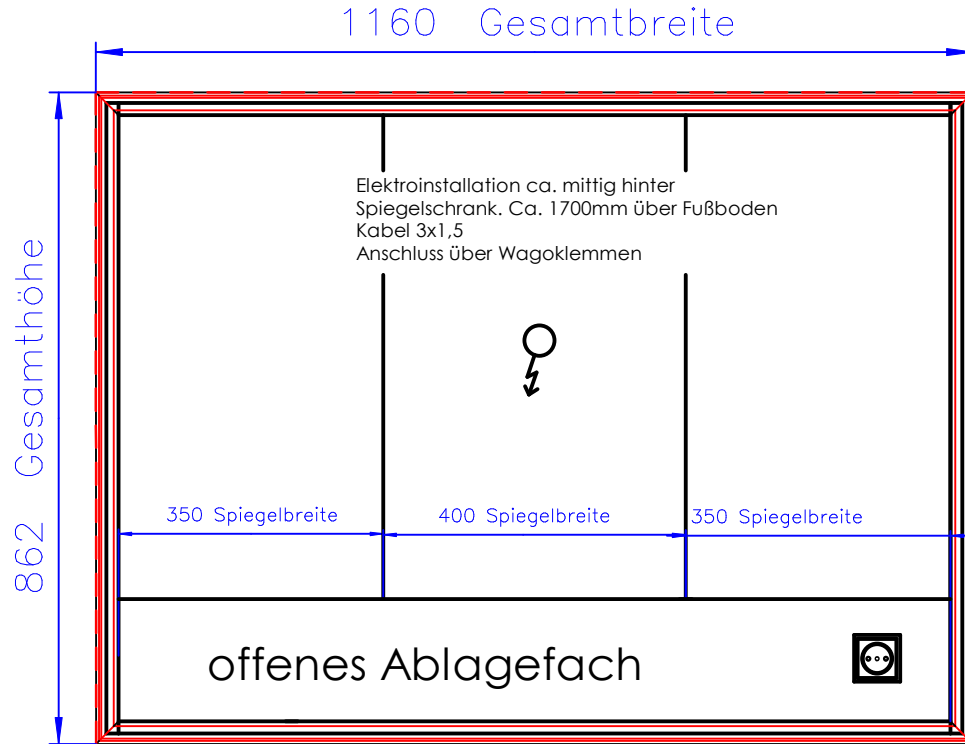

SOL15-11867-503

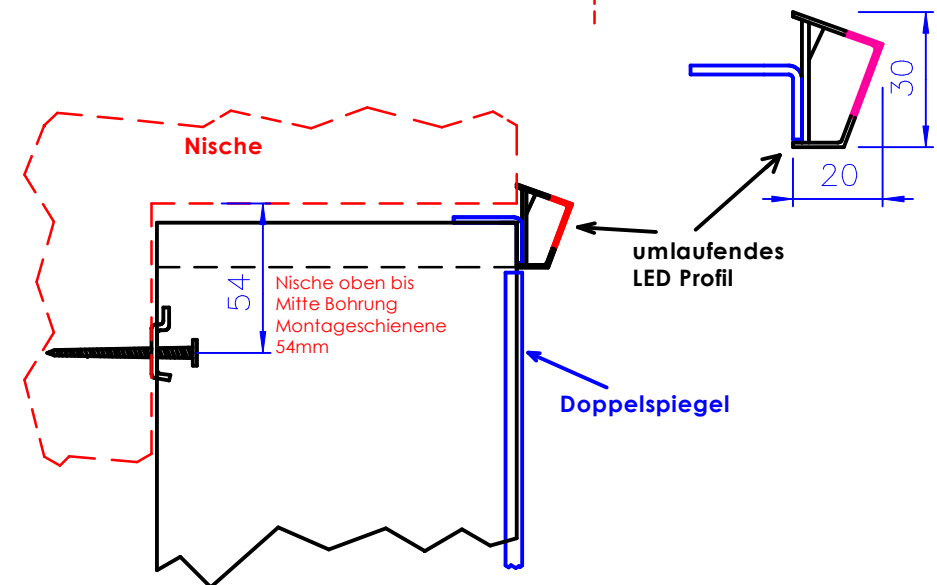
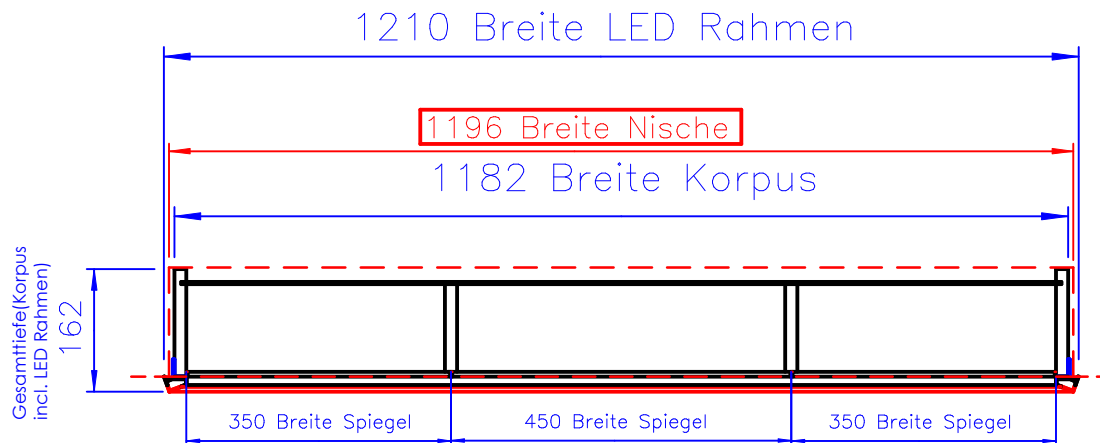
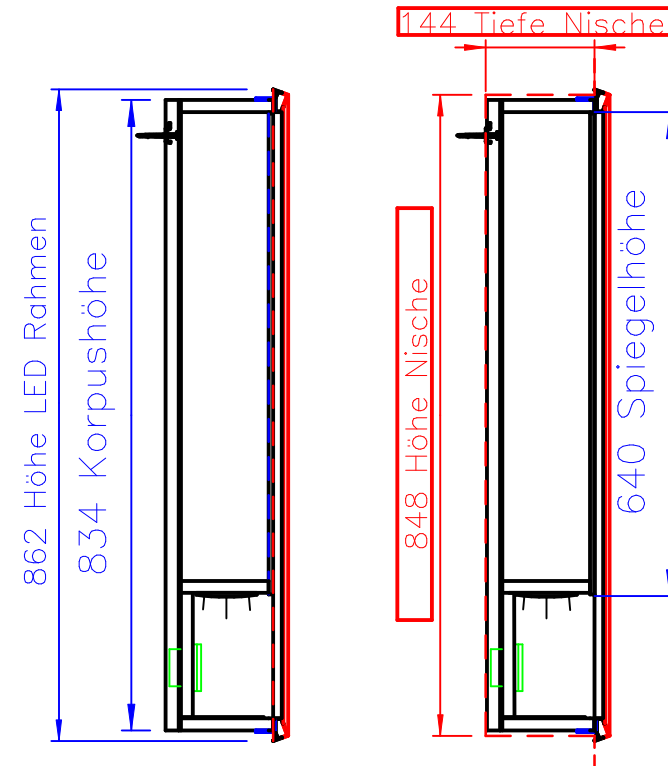
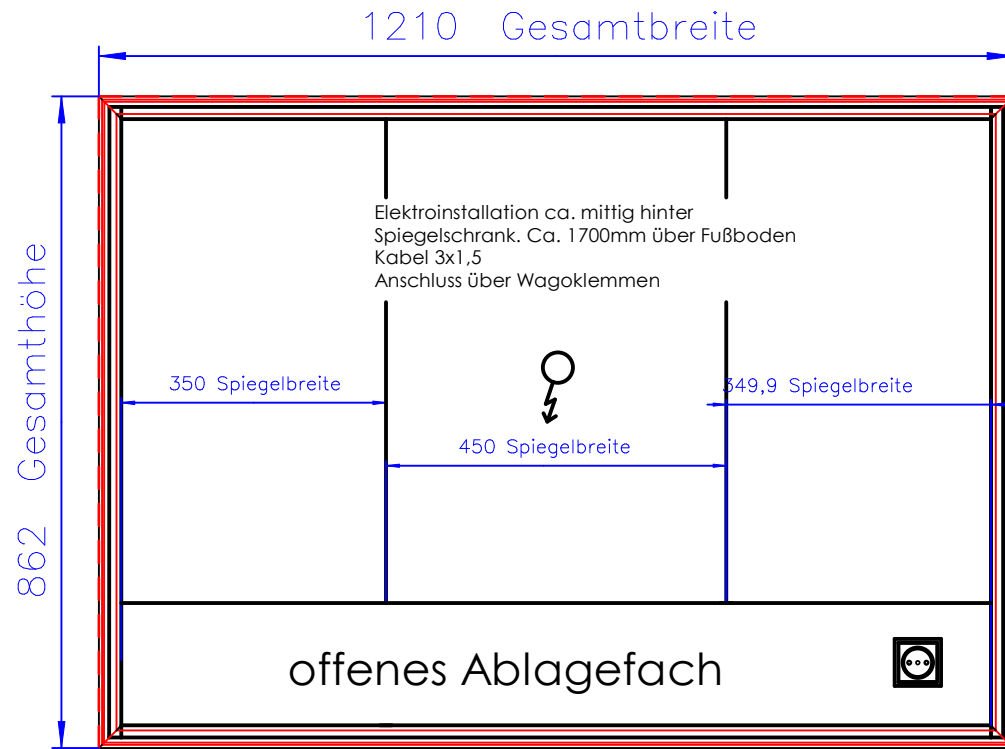

SOL15-12367-503

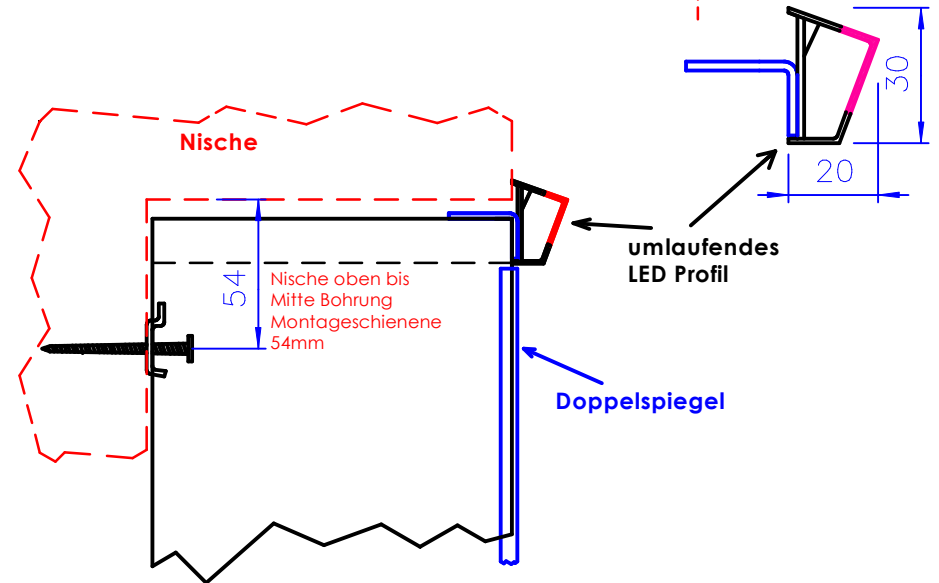
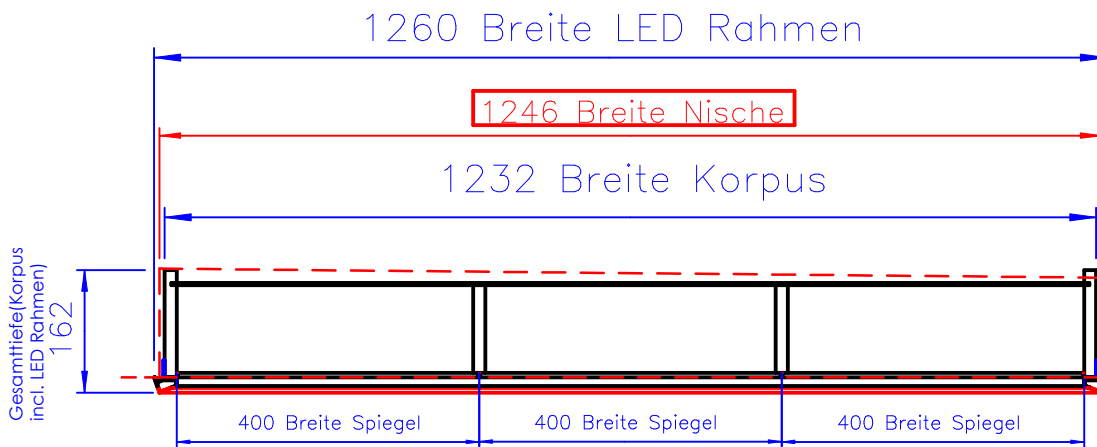
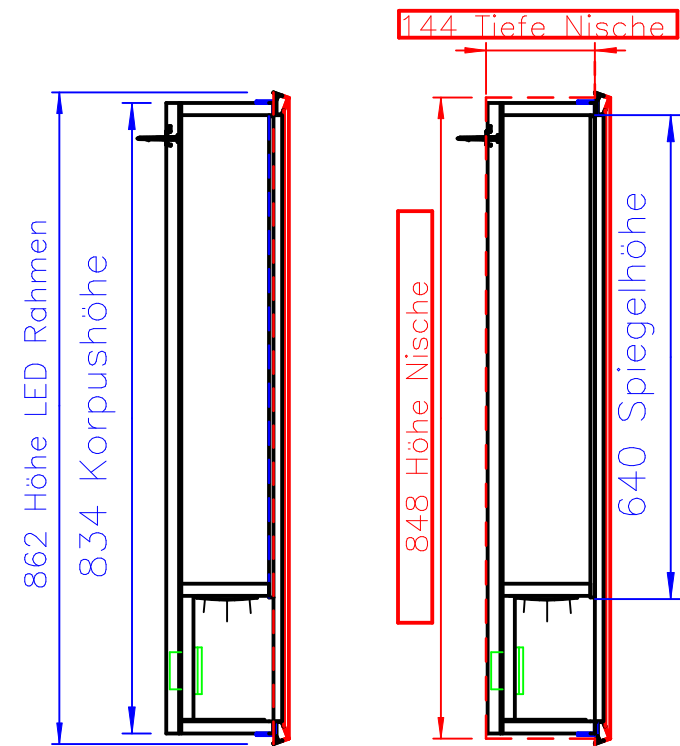
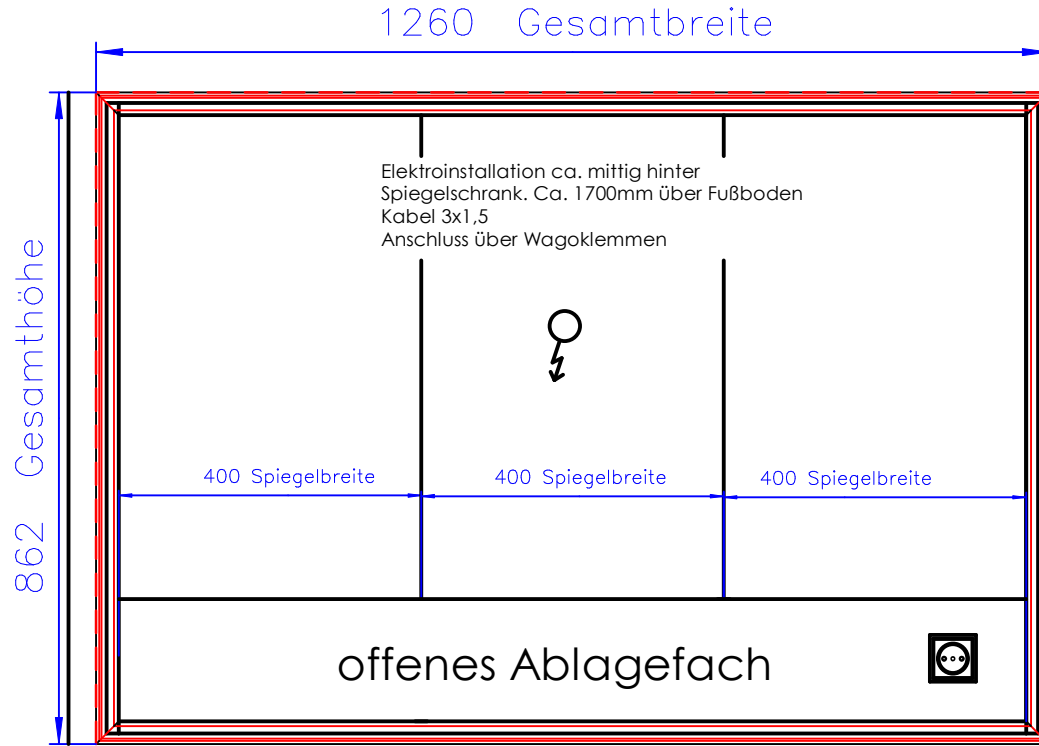

SOL15-12867-503

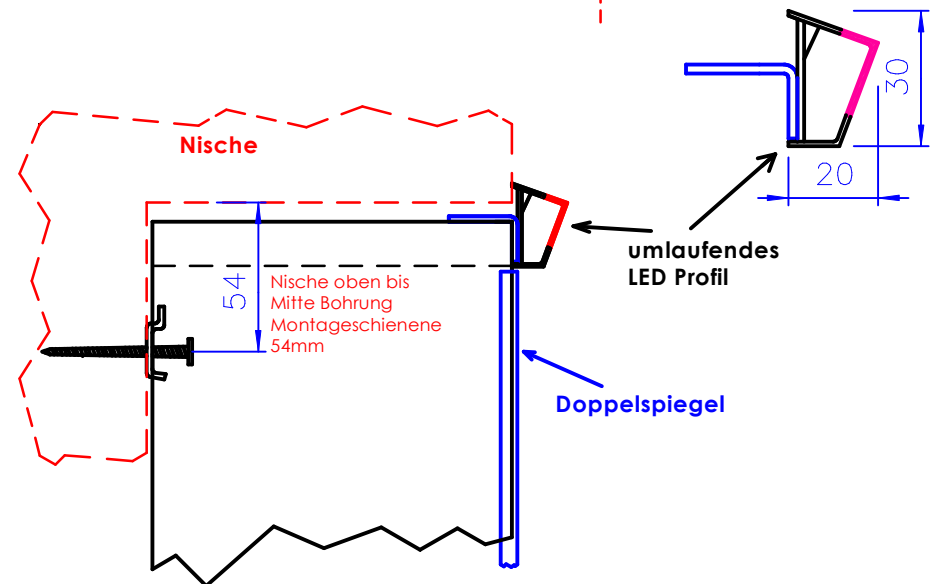
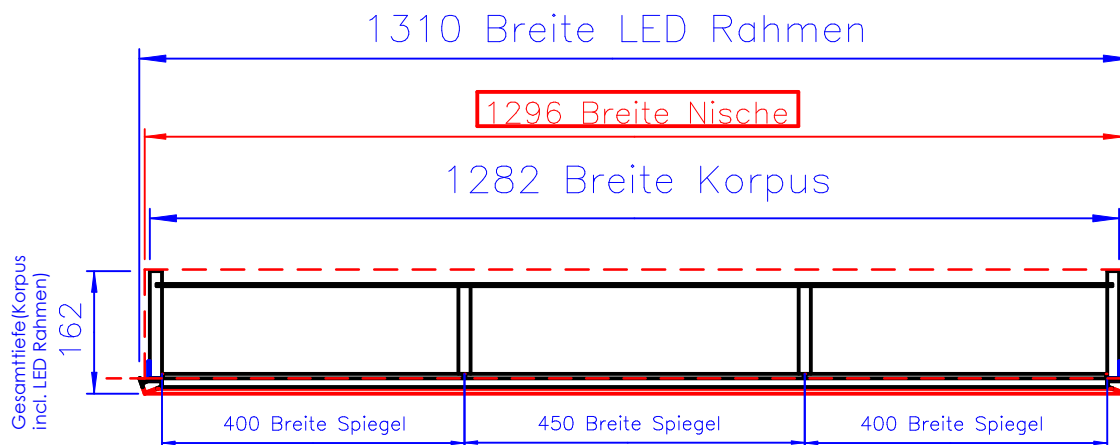
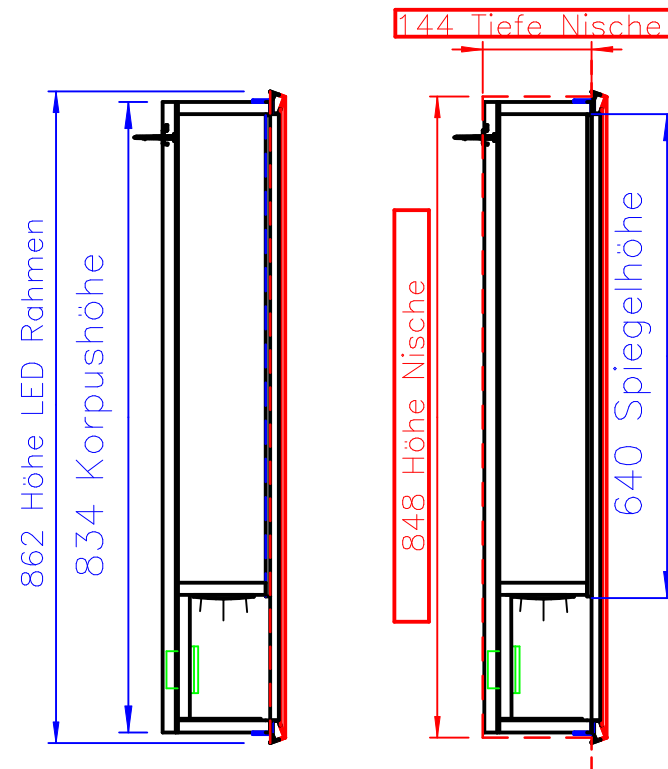
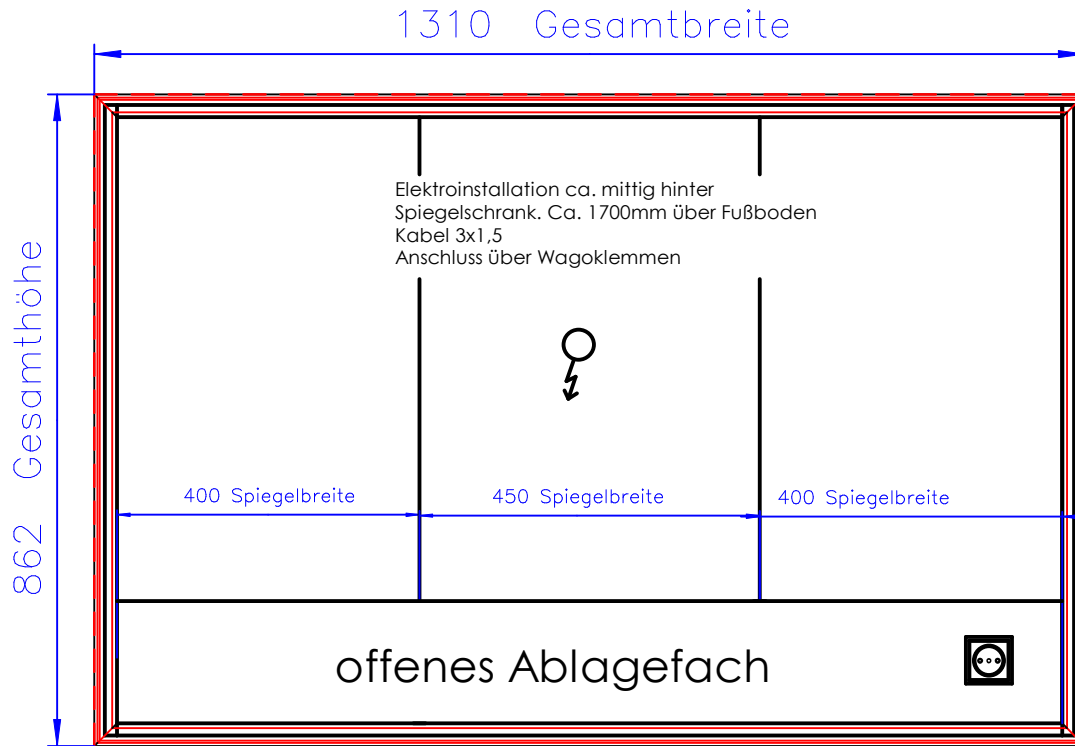

SOL15-13367-503

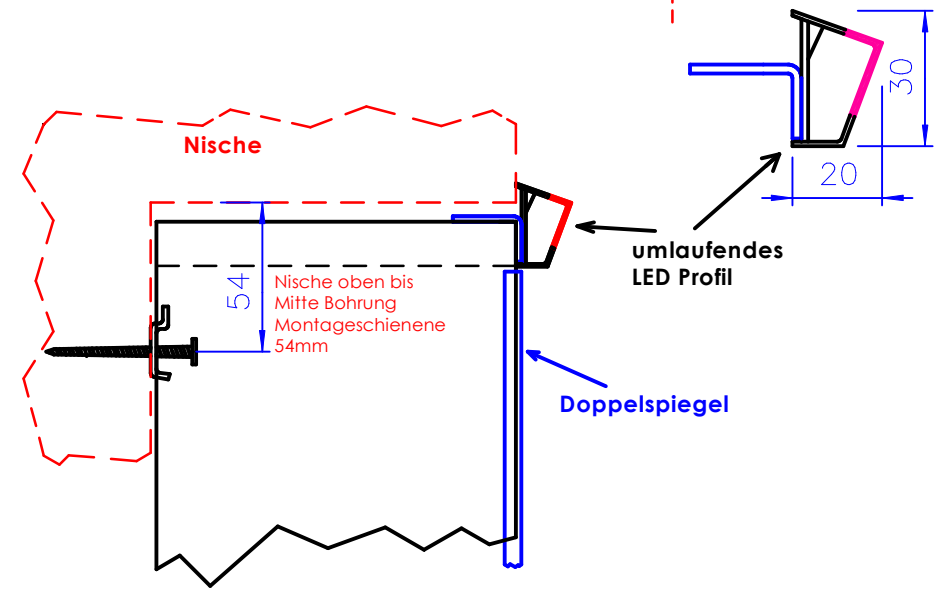
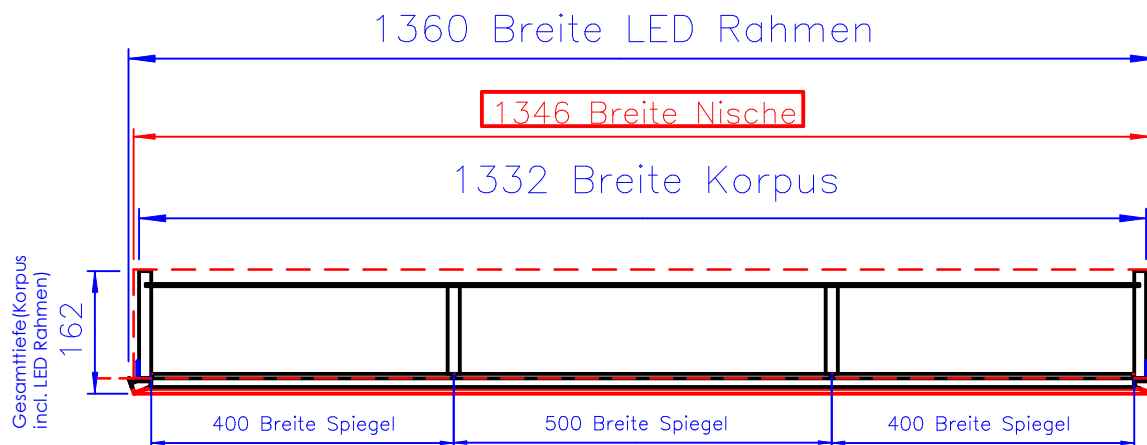
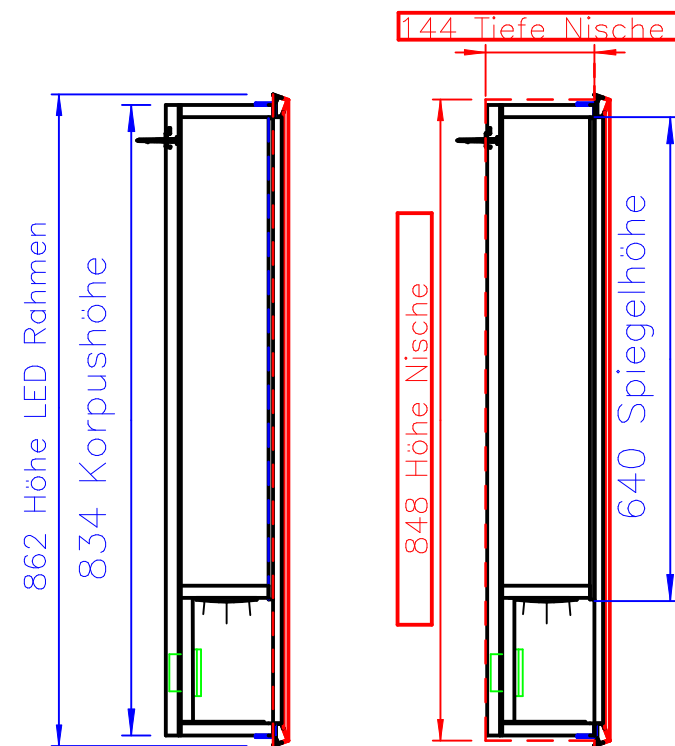
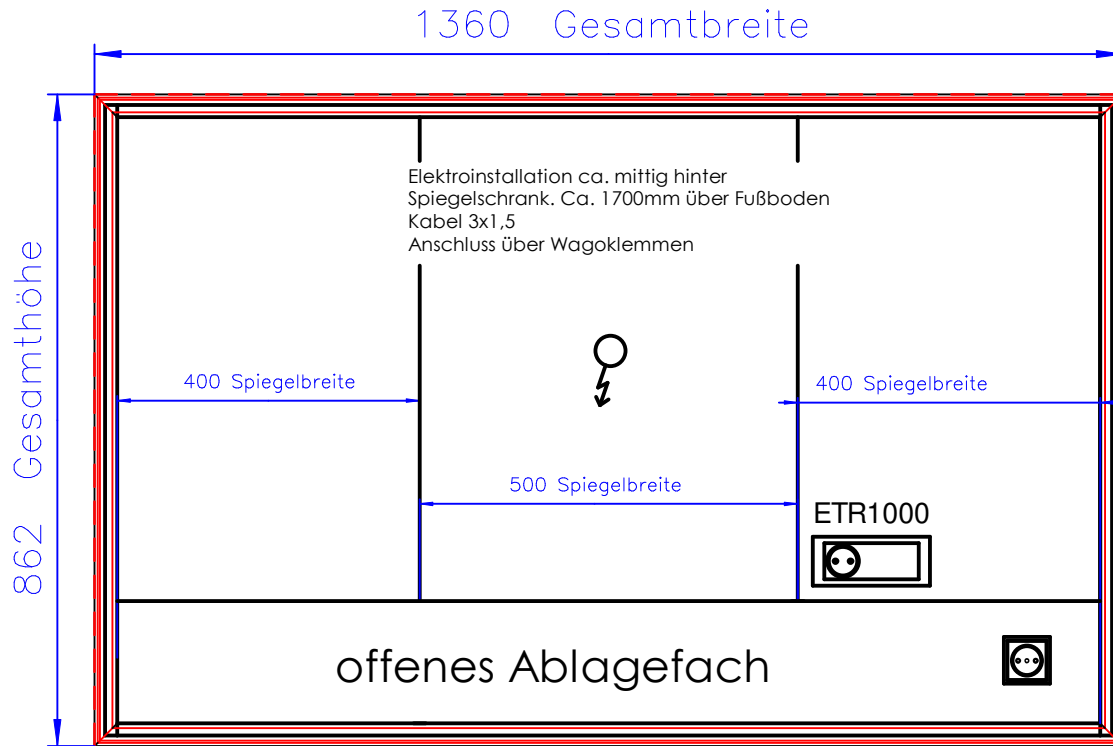

SOL15-14867-503

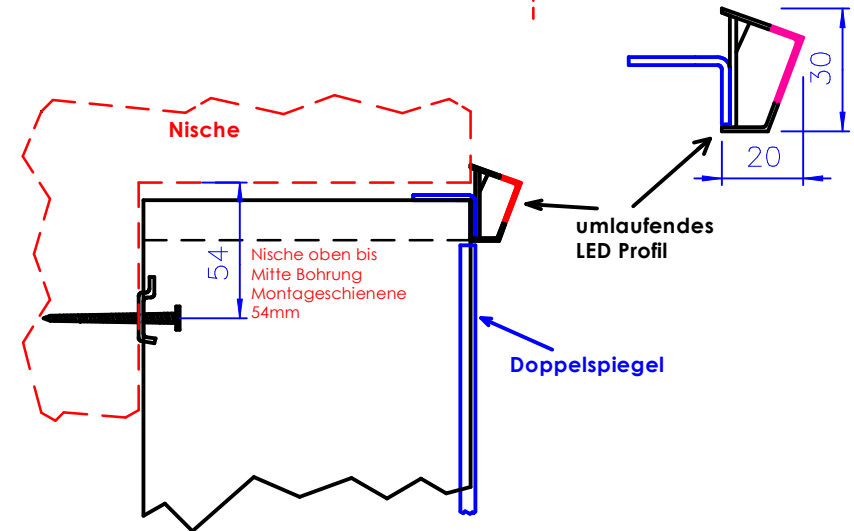
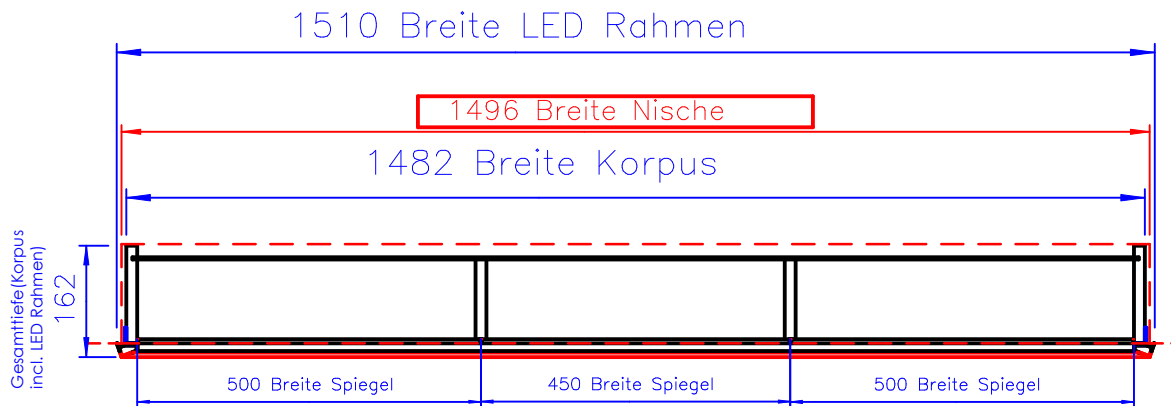
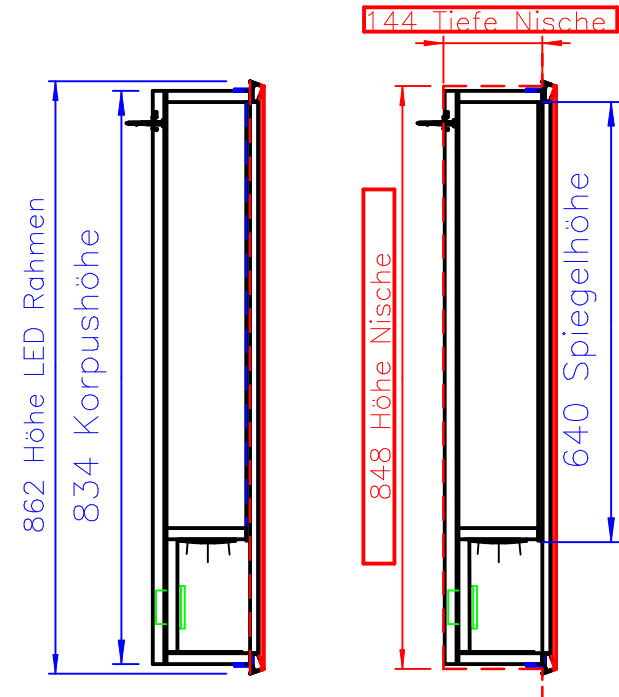
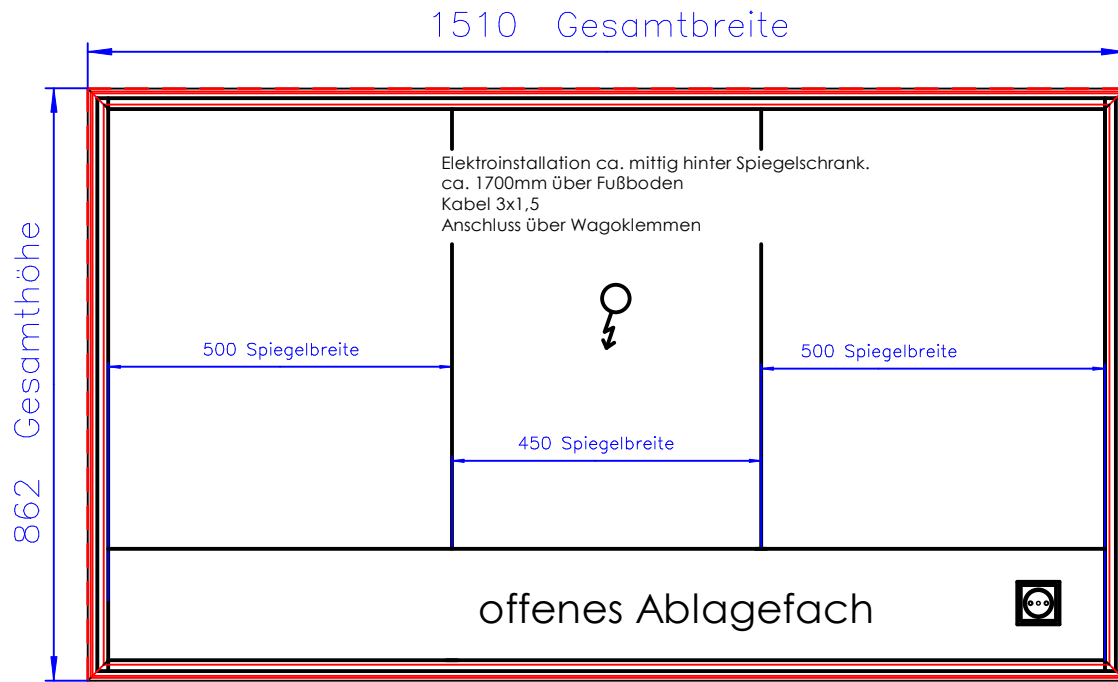

SOL15-15867-503

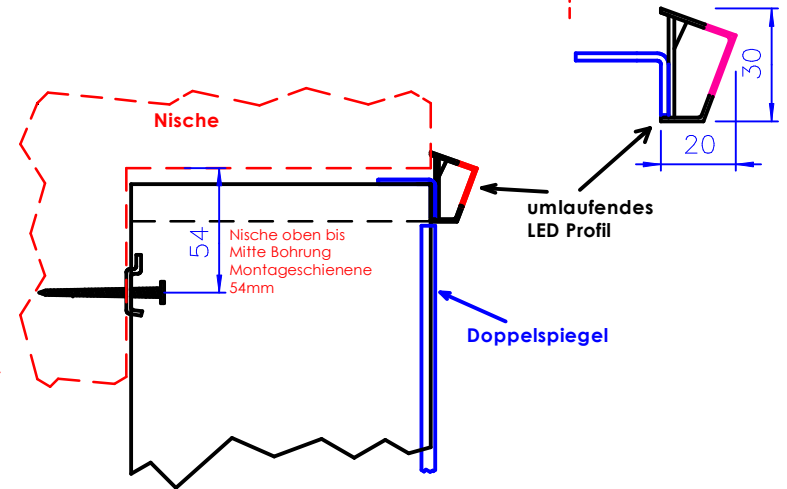
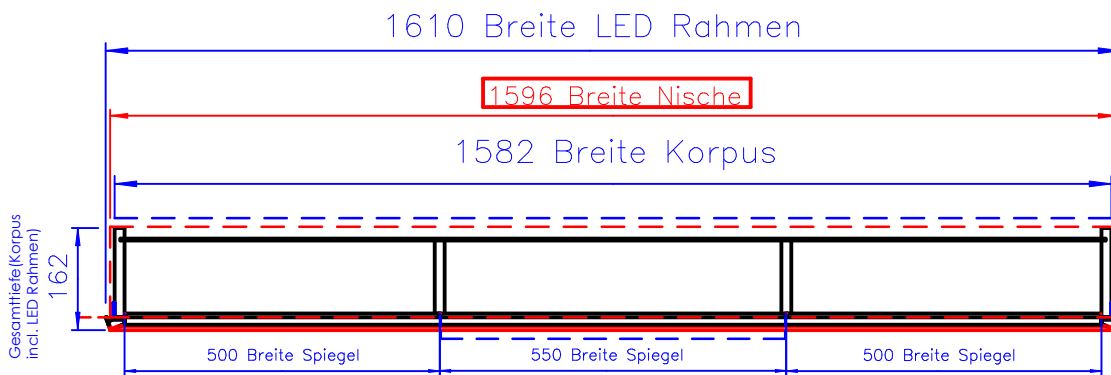
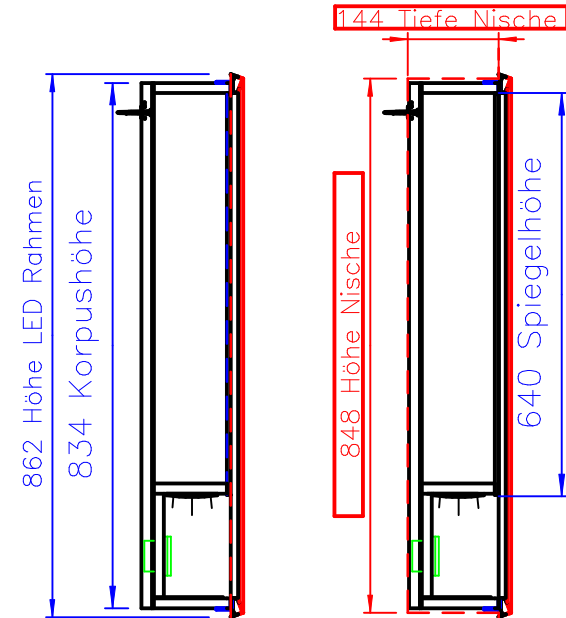
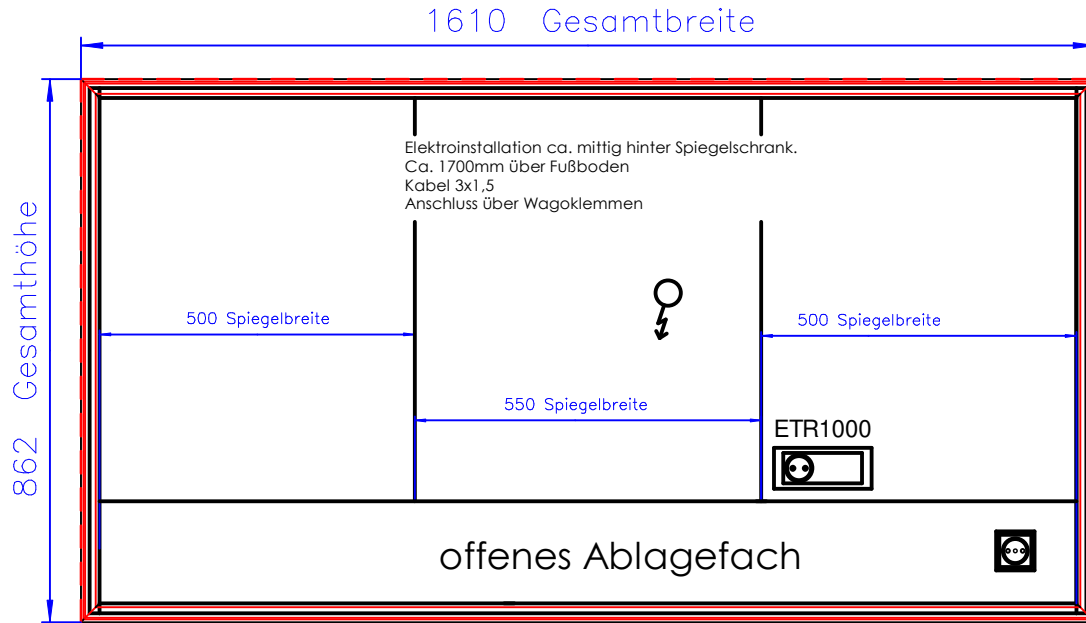

SOL15-16367-503

